

Operating Manual

Charging Station for Charging Battery Electric Vehicles (BEV)

i-CHARGE CION

Operating Manual V2.2 (Translation from the German Original)

© Schrack Technik GmbH

2023 All rights reserved.

We have verified that the content of this documentation matches the hardware and software described therein. Nevertheless, deviations, remaining errors and omissions cannot be ruled out. Therefore, we expressly do not accept any liability for damage that may result therefrom.

However, the information in this publication is checked regularly and necessary corrections will be included in subsequent versions. We are grateful for any suggested improvements submitted.

Technical information subject to change.

Contents

- 1 Introduction..... 8
 - 1.1 Preamble 8
 - 1.2 Manufacturer contact details..... 8
 - 1.3 Markings..... 9
 - 1.4 Technical data..... 10
 - 1.4.1 General 10
 - 1.4.2 Home 11
 - 1.4.3 Semipublic 11
 - 1.4.4 Pro Online & Ethernet 11
 - 1.4.5 RFID reader..... 12
 - 1.5 Warranty and liability..... 12
 - 1.6 Content and scope of this documentation..... 13
 - 1.7 Validity..... 13
 - 1.8 Recommendation 13
- 2 Limits of use..... 14
 - 2.1 Intended use..... 14
 - 2.2 Reasonably foreseeable misuse 14
 - 2.3 Operating conditions..... 15
 - 2.4 Target group and prior knowledge..... 15
 - 2.5 Principle..... 16
- 3 Safety..... 17
 - 3.1 Classification of document conventions 17
 - 3.1.1 Warnings and safety instructions..... 17
 - 3.1.2 Instructions..... 18
 - 3.1.3 Information..... 18
 - 3.2 Signal words and safety instructions used 18
 - 3.3 Warning, mandatory and prohibitory signs used..... 19
 - 3.3.1 Warning signs 19
 - 3.3.2 Mandatory signs 19
 - 3.3.3 Prohibitory signs..... 19
 - 3.4 General safety instructions 20
 - 3.5 General regulations 20
 - 3.6 Warning, mandatory and prohibitory signs on the product 22
 - 3.7 Safety elements & temperature monitoring..... 22
- 4 Installation/ initial operation..... 23

4.1	Transportation.....	23
4.2	Installation conditions	23
4.3	Storage	23
4.4	Installation site	23
4.5	Mounting.....	24
4.5.1	Scope of delivery	25
4.5.2	Wall mounting and electrical connection	26
4.5.3	Installation on mounting pole	39
4.6	Installation regulations.....	40
4.7	Initial operation	41
4.8	Operator handover.....	41
5	Operation	42
5.1	Operating elements.....	42
5.1.1	Charging socket	43
5.1.2	Charging cable	44
5.2	Display elements – LED status display.....	45
5.2.1	CION Home (EMCIONHxxx)	45
5.2.2	CION Semipublic (EMCIONSxxx)	48
5.2.3	CION Pro (EMCIONP2xx).....	54
6	Configuration.....	55
6.1	Configuration of charge controller for Home and Semipublic models	55
6.1.1	12 V DC actuator (external activation)	56
6.1.2	Integration of photovoltaic & smart home systems	57
6.2	Configuration of charge controller for CION Pro models.....	61
6.2.1	Configuration Manual.....	61
6.2.2	Load management.....	61
7	Maintenance.....	63
7.1	Inspection	63
7.2	Cleaning	64
7.3	Servicing	64
7.4	Spare and wear parts	65
7.5	Repair	65
7.6	Periodic inspection	66
7.7	Shutdown	66
7.8	Dismantling.....	66
7.9	Disposal	67

8	Maximum back-up fuse	68
9	Appendix.....	70
9.1	Dimensions - drill template	70
9.2	Spare and wear parts	71
9.3	Unit table	71
9.4	Packaging icons.....	72
9.5	Notes	73

Table of Figures

<i>Figure 1</i>	<i>CE mark symbol</i>	<i>9</i>
<i>Figure 2</i>	<i>Positioning the drill template on the wall</i>	<i>26</i>
<i>Figure 3</i>	<i>Drilling the holes in the wall</i>	<i>27</i>
<i>Figure 4</i>	<i>Inserting the wall plugs</i>	<i>28</i>
<i>Figure 5</i>	<i>Opening the cover</i>	<i>29</i>
<i>Figure 6</i>	<i>Removing the connection cable.....</i>	<i>30</i>
<i>Figure 7 and 8</i>	<i>Drilling the cable inlets from the rear I and from below II.....</i>	<i>31</i>
<i>Figure 9 and 10</i>	<i>Inserting the feed cable from the rear I and from below II</i>	<i>32</i>
<i>Figure 11</i>	<i>Mounting the wall box on the wall.....</i>	<i>33</i>
<i>Figure 12</i>	<i>Connecting the feed to the terminal block - 3-phase connection.....</i>	<i>34</i>
<i>Figure 13</i>	<i>Connecting the feed to the terminal block - 1-phase connection.....</i>	<i>35</i>
<i>Figure 14</i>	<i>Checking the correct feed line position - correct</i>	<i>36</i>
<i>Figure 15</i>	<i>Checking the correct feed line position - incorrect</i>	<i>36</i>
<i>Figure 16</i>	<i>Checking the cable attachment.....</i>	<i>37</i>
<i>Figure 17</i>	<i>Connecting the connection cable (RFID reader, LED board).....</i>	<i>38</i>
<i>Figure 18</i>	<i>Mounting the cover</i>	<i>39</i>
<i>Figure 19</i>	<i>Charging socket</i>	<i>43</i>
<i>Figure 20</i>	<i>Charging cable.....</i>	<i>44</i>
<i>Figure 21</i>	<i>Home - Stand-by operation</i>	<i>45</i>
<i>Figure 22</i>	<i>Home - Connecting the BEV.....</i>	<i>46</i>
<i>Figure 23</i>	<i>Home - Charging complete</i>	<i>46</i>
<i>Figure 24</i>	<i>Home - Charging error.....</i>	<i>47</i>
<i>Figure 25</i>	<i>Home - Charging paused</i>	<i>47</i>
<i>Figure 26</i>	<i>Semipublic - Ready.....</i>	<i>48</i>
<i>Figure 27</i>	<i>Semipublic - Authentication</i>	<i>49</i>
<i>Figure 28</i>	<i>Semipublic - Charging in progress</i>	<i>50</i>
<i>Figure 29</i>	<i>Semipublic - Charging complete/paused.....</i>	<i>50</i>
<i>Figure 30</i>	<i>Semipublic - Teaching a charge card</i>	<i>51</i>
<i>Figure 31</i>	<i>Semipublic - Teaching a charge card completed</i>	<i>52</i>
<i>Figure 32</i>	<i>Semipublic - Error message</i>	<i>53</i>
<i>Figure 33</i>	<i>Pro status LEDs</i>	<i>54</i>
<i>Figure 34</i>	<i>DIP switch charge controller Home & Semipublic</i>	<i>55</i>
<i>Figure 35</i>	<i>Charge controller schematic 0-10 V interface</i>	<i>57</i>
<i>Figure 36</i>	<i>Charge controller schematic Modbus RTU</i>	<i>59</i>
<i>Figure 37</i>	<i>CION Pro wiring schematic</i>	<i>62</i>
<i>Figure 38</i>	<i>Back-up fuse schematic RCCB + MCB</i>	<i>69</i>

Figure 39 Back-up fuse schematic RCBO 69
 Figure 40 Drill template 70

Table of Tables

Table 1 Contact details 8
 Table 2 Markings 9
 Table 3 Technical data - CION general 10
 Table 4 Technical data - CION Home 11
 Table 5 Technical data - CION Semipublic 11
 Table 6 Technical data - CION Pro Online & Ethernet 11
 Table 7 Technical data - RFID reader 12
 Table 8 Operating conditions 15
 Table 9 Warning signs 19
 Table 10 Mandatory signs 19
 Table 11 Prohibitory signs 19
 Table 12 Pictograms on the product 22
 Table 13 Pro status LEDs explanation 54
 Table 14 DIP switch settings charge controller Home & Semipublic 55
 Table 15 Modbus RTU register charge controller Home & Semipublic 60
 Table 16 Spare and wear parts 71
 Table 17 Unit table 71
 Table 18 Packaging icons 72

Versions

Version	Date	Description
1.0	23/04/2020	Operating Manual CION V1.0
1.1	19/05/2020	Extension of configurations
1.2	05/08/2020	Extension of Modbus config. Clarification 1~/3~ operation
1.3	22/09/2020	Extension of actuator, optional ventilation requirement
1.4	28/01/2021	Correction Online CION
2.0	16/02/2022	Extension CION Pro
2.1	04/01/2023	Successor products for CION Home and CION Semipublic
2.2	16/11/2023	Correction of the configuration of the DIP switches and the maximum back-up fuse

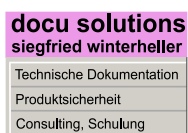

Documentation created by:

docu solutions Siegfried Winterheller

Unterer Bründlweg 15, 8054 Graz, Austria

office@docusolutions.at

+43 (0)664 3507749

Copyright ©

The original documentation and this translation are protected by copyright. In case of discrepancies the German original version shall take precedence. All rights, in particular the rights to copy, distribute and translate, are reserved. No part of this manual may be reproduced in any form or stored, processed, copied, or distributed using electronic systems without written permission from Schrack Technik GmbH. Violations may result in criminal prosecution.

© 2023 Schrack Technik GmbH

1 Introduction

With this charging station you have acquired a state-of-the-art product as regards safety for operators and operating reliability. Nevertheless, this charging station may pose hazards if it is misused or not used as intended (for details, see chapter 3), even though this documentation points out hazards by means of safety instructions wherever applicable.

1.1 Preamble

The present documentation supports the safe working on and with the charging station. It contains safety instructions which must be strictly observed! All people working on and with the charging station, must have the documentation readily available during work and observe the information and instructions relevant to them.

The documentation must always be provided complete and must be perfectly readable.

The company Schrack Technik GmbH accepts no liability for technical or typographical defects in this documentation, nor does it accept liability for damage that is directly or indirectly attributable to the delivery, performance, or use of this documentation.

1.2 Manufacturer contact details

If the product shows malfunctions, the cause of which you cannot remedy with the help of this documentation, please contact Schrack Technik GmbH.

Manufacturer	Schrack Technik GmbH
Address	Seybelgasse 13, A - 1230 Vienna, Austria,
Telephone	+43 1 866 85 ext. 0
Email	info@schrack.com
Website	www.schrack.com

Table 1 Contact details

1.3 Markings

This product is unequivocally marked by the content of the rating plate.

Example of a rating plate EMCION22PR:







Rating plate on inside – 80 x 60 mm	Rating plate on outside– 50 x 23 mm
 <p>SCHRACK TECHNIK</p> <p>Ladestation Typ:i-CHARGE CION 22kW Typ2 Buchse,lokales RFID-System 400V 32A 50Hz 3~ Schutzart: IP54 Art.Nr.:EMCION22PR DMAT:- SN:200000116 Datum: 17.04.2019</p> <p>Hersteller: Schrack Technik GmbH Seybelgasse 13 A-1230 Wien Hergestellt in Österreich</p>  	 <p>Schrack Technik GmbH EMCION22PR S/N: 200000116 PD: 1120 400V 32A 50Hz 3~ IP54</p>   

Table 2 Markings

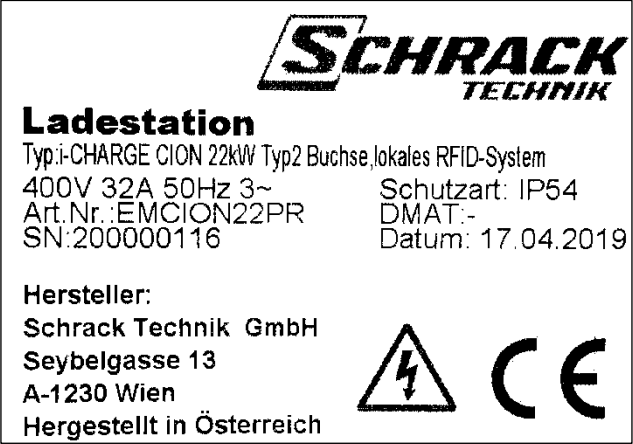
CE marking acc. to:

- Directive 2014/35/EU of the European Parliament and of the Council relating to the making available on the market of electrical equipment designed for use within certain voltage limits.
- Directive 2014/30/EU of the European Parliament and of the Council relating to electromagnetic compatibility.
- Directive 2014/53/EU of the European Parliament and of the Council relating to the making available on the market of radio equipment.
- Directive 2011/65/EU of the European Parliament and of the Council relating to the restriction of the use of certain hazardous substances in electrical and electronic equipment.



Figure 1 CE mark

The product is provided with the CE mark in accordance with the requirements of the European Union for marking products.

The corresponding declaration of conformity is available from Schrack Technik GmbH and can be downloaded from www.schrack.com/services/cion-docu.

1.4 Technical data

1.4.1 General

Order Number	EMCION11Cx	EMCIONx2Cx	EMCIONx2Px
Charging point	TYPE 2 cable 5 m (gross), 4.7 m (net) 3.7 - 11 kW	TYPE 2 cable 5 m (gross), 4.7 m (net) 3.7 - 22 kW	TYPE 2 socket 3.7 - 22 kW
Charging current levels ⁽¹⁾	1~: 13 A; 16 A 3~: 13 A; 16 A	1~: 13 A; 16 A 3~: 13 A; 16 A; 20 A; 32 A	
Power supply ⁽¹⁾	1~/N/PE; 230 V; 16 A 3~/N/PE; 400 V; 16 A	1~/N/PE; 230 V; 16 A 3~/N/PE; 400 V; 32 A	
Maximum rating for back-up fuse ...			
... at 13 A	Circuit breaker C 16 A ⁽²⁾ ; Residual current protection type A 30 mA		
... at 16 A	Circuit breaker C 20 A ⁽²⁾ ; Residual current protection type A 30 mA		
... at 20 A	Circuit breaker C 25 A ⁽²⁾ ; Residual current protection type A 30 mA		
... at 32 A	Circuit breaker C 40 A ⁽²⁾ ; Residual current protection type A 30 mA		
Rated output ⁽³⁾	11 kVA	22 kVA	
Temperature range	-30 °C to 50 °C	-30 °C to 50 °C (up to 16 A) -30 °C to 40 °C (up to 32 A)	
Enclosure material	Polycarbonate (PC), front: light grey, rear: blue grey		
Ratings	IK10; IP54		
Supply line	Max. clamping cross section 5x10 mm ² (suitable for copper and aluminium conductors)		
Cable inlet	Included M20, M25 and M32 sealing glands (max. cross section 21 mm) for supply and control line from below Included stepped gland max. cross section 21 mm for supply line from the rear		
Dimensions	H490 x W274 x D180 mm		
<p>⁽¹⁾ At max. load depending on 1- or 3-phase power supply. Charging current/power can be set on site.</p> <p>⁽²⁾ Maximum rating for the back-up fuse, which can be used, when it is necessary due to the thermal derating. Otherwise, a fuse with the rated current has to be used.</p> <p>⁽³⁾ For 3-phase power supply line and at maximum charging current.</p>			

Table 3 Technical data - CION general

1.4.2 Home

Order Number	EMCION11C-	EMCION22C-	EMCION22P-
Weight	4.5 kg	5.7 kg	3.5 kg
Authentication	-		
Payment	-		
Load management	MODBUS RTU via RS485; 0-10 V interface; 12 V actuator		
Safety element	Integrated 6 mA DC residual current detection		

Table 4 Technical data - CION Home

1.4.3 Semipublic

Order Number	EMCION11CR	EMCION22CR	EMCION22PR
Weight	4.5 kg	5.7 kg	3.5 kg
Authentication	Local RFID via RS232		
Payment	-		
Load management	MODBUS RTU via RS485; 0-10 V interface; 12 V actuator		
Safety element	Integrated 6 mA DC residual current detection		

Table 5 Technical data - CION Semipublic

1.4.4 Pro Online & Ethernet

Order Number	EMCIONP2CO	EMCIONP2CE	EMCIONP2PO	EMCIONP2PE
Weight	6 kg		3.8 kg	
Authentication	RFID; QR code (by charging station operator/backend)			
Modem	4G/3G/2G	-	4G/3G/2G	-
Network	Ethernet 10/100 Mbit			
Minutes	OCPP 1.5/1.6 SOAP/JSON			
Interfaces	1x RJ45; 1x USB 2.0 micro-B; 2x USB 1.0/2.0 type-A			
Load management	Modbus TCP/IP, defined total power, optional master meter TCP/IP			
Safety element	Integrated 6 mA DC residual current detection			

Table 6 Technical data - CION Pro Online & Ethernet

1.4.5 RFID reader

Order Number	EMCIONSxxx / EMCIONPxxx
Interfaces	RS232 or I2C
Standard	ISO 14443 (A and B)
Examples	MIFARE DESFire, Classic 1K/4K, Ultralight, Plus, SmartMX

Table 7 Technical data - RFID reader

Further technical data are available in the respective data sheets and in the appendix to this Operating Manual. The data sheets are available online for download at www.schrack.com/services/cion-docu.

1.5 Warranty and liability

The warranty period of the charging station is 2 years and begins on the date of the initial operation. This operating manual serves to ensure fault-free and safe use of the product; compliance with its content is a prerequisite for the fulfilment of any warranty claims.

Excluded from the warranty are such defects that result from any arrangement and assembly not effected by the seller, insufficient equipment, failure to observe the installation requirements and conditions of use, excessive load on the components beyond the capabilities specified by the seller, negligent or incorrect handling, and use of unsuitable operating materials; this also applies to defects that are attributable to material provided by the buyer.

Wear parts as specified in Appendix 9.2 are also excluded from the warranty.

The seller shall only be liable for damage outside the scope of application of the Austrian Product Liability Act if intent or gross negligence can be proven against him, within the scope of the statutory provisions.

Claims for damages expire in particular in the event of

- Inappropriate use
- Faulty assembly, electrical and mechanical installation and protection
- Operation with defective or improperly installed safety devices and protective equipment
- Failure to follow the instructions in this documentation
- Non-use of original spare parts
- Modifications or additions, if this has not been agreed and approved in writing with Schrack Technik GmbH

-
- Repairs carried out improperly
 - Disasters, foreign body impact and force majeure

The seller is also not liable for damage caused by the actions of third parties, atmospheric discharges, overvoltage and chemical influences. The warranty does not apply to the replacement of parts that are subject to natural wear and tear.

In addition, warranty and compensation claims are exclusively subject to the General Terms of Delivery issued by The Austrian Electrical and Electronics Industry Association. They are published in German and can be downloaded at www.feei.at. We will provide you with a copy on request. Deliveries are made under retention of title.

1.6 Content and scope of this documentation

This documentation contains information that is relevant to ensure that working with the product is as safe as possible. Observing the instructions in this document helps to avoid hazards and prevents the product from sustaining damage. In addition to this operating manual, it is mandatory to observe the regulations for the prevention of accidents and for environmental protection applicable in the country and the location where the product is installed.

1.7 Validity

This manual exclusively applies to the specific product with the designation i-CHARGE CION from the company Schrack Technik GmbH. The product was placed on the market by Schrack Technik GmbH.

1.8 Recommendation

We recommend to have repairs and maintenance made by either the company Schrack Technik GmbH or by our certified i-CHARGE Partners, who are familiar with and trained in our products and can therefore offer the best service to you.

2 Limits of use

2.1 Intended use

This charging station is an electrical equipment designed for charging battery electric vehicles (BEV). Plugs and sockets according to EN 62196 (alternating current charging, mode 3) are used for charging BEVs. The charging station is suitable for use indoors and outdoors.

The product is built according to the state of the art and the generally accepted safety regulations. Nevertheless, during its use hazards to life and limb of the operator or third parties may occur or the product and other material assets may be negatively affected. Intended use includes observing the operating manual and compliance with the maintenance requirements. Only use the product if it is in technically perfect condition.

Use the product as intended and in a safety-conscious manner. Have malfunctions or damage that could impair safety remedied immediately by Schrack Technik GmbH or a certified i-CHARGE Partner.

2.2 Reasonably foreseeable misuse

The charging station must be mounted on a wall or on the Schrack mounting pole EMCIONS1 / EMCIONS2 and installed stationary. It is not allowed to operate the charging station in a loose state (not steadily mounted) – because this would not comply with the ratings.

- Unmounting, tampering with or deactivating the safety devices is forbidden.
- No technical changes may be made to the product without consulting Schrack Technik or a certified i-CHARGE Partner.
- Furthermore, liability and warranty claims are excluded in case of non-compliance with the intended use.
- The product may only be operated under the operating conditions specified in the documentation.

2.3 Operating conditions

Ambient temperature:	-30 to +50 °C at 16 A -30 to +40 °C at 32 A
Installation site:	Indoors and outdoors (garage, underground car park, exterior wall, car repair shop, parking spaces on mounting poles) The wall must be able to support the device (for details, see chapter 4.5)
Relative humidity:	5 to 95%
Use:	Possible daily if required

Table 8 Operating conditions

To ensure colour fastness, it is recommended to protect the charging station from direct UV and sunlight. In extreme cases such exposure can lead to an increase in temperature inside the station, which results in a power reduction or ultimately in an interruption of the charging process.

If the charging station is positioned at locations fully exposed to the elements, very low temperatures in combination with snow and ice may cause ice to accumulate on the EMCIONxxCx with the charging cable in parking position. In that case, please put the protective cap over the charging plug and roll up the charging cable over the top of the station as described instead of putting it in the parking position.

2.4 Target group and prior knowledge

This documentation is addressed to qualified personnel for installation and initial operation as well as to the user (layperson) for operation and maintenance of the product.

User (layperson)

Unattended operation of the product by laypersons is only allowed if they

- Have read and understood this Operating and Maintenance Manual,
- Have read and understood all the safety instructions.

Qualified personnel (electrical engineering specialist)

Only qualified personnel is allowed to perform initial operation, inspection and configuration work. The qualified personnel must have read and understood this Operating and Maintenance Manual. We recommend a corresponding certification as i-CHARGE Partner from Schrack Technik GmbH.

Qualified personnel (certified i-CHARGE Partners)

Only certified i-CHARGE Partners are allowed to perform initial operation, service, repair, overhaul, inspection, configuration, and maintenance work. The qualified personnel must have read and understood this Operating and Maintenance Manual.

2.5 Principle

The product conforms with the state of the art and the applicable safety and health regulations. Nevertheless, the following dangers can be caused by incorrect operation or misuse:

- Hazards to life and limb of the user or third parties
- Perils to the product and other material assets of the operator
- Risks for the efficient use of the product

3 Safety

This documentation is designed according to the applicable EU regulations and contains safety instructions. The operator of the product must be handed over the necessary safety-relevant information and read the documentation. Each individual is responsible for following the safety instructions.

This chapter contains a general introduction to the safety instructions and the description of the warnings and safety instructions depicted on the safety markings attached to the product. Here you also find important notes on accident prevention.

3.1 Classification of document conventions

This document contains the following types of instructions:

- Warnings and safety instructions
- Instructions
- Information

3.1.1 Warnings and safety instructions

This document contains safety instructions which you have to comply with for your own safety and to avoid damage to property. Warnings and safety instructions inform the user of hazards which may result in light, severe physical injury or even death, or cause considerable damage to property if the corresponding instructions are not followed.

In each chapter these warnings indicate the corresponding hazards. The structure of warnings and safety instructions is identical. Safety instructions and warnings are highlighted by a warning triangle icon; they must be strictly observed.





3.1.2 Instructions

Instructions contain important information about a product, the handling of the product, or that part of the documentation to which they draw attention. The failure to observe such information can have disadvantageous effects which, however, only exceptionally and in rare cases can lead to hazards for people or the product. In all cases instructions must always be carefully read and observed in order to ensure correct operation and functioning.

3.1.3 Information

Information refers to additional comments or hints on a section of this manual or about the product, the handling of the product, or that part of the documentation to which they draw attention. They should be observed in order to obtain a potential benefit. All Information sections should be carefully read and observed in the interest of optimal use and operation of the product.

3.2 Signal words and safety instructions used

DANGER	
	<p>Imminent danger.</p> <p>Severe and permanent injury or death.</p>
WARNING	
	<p>Potentially dangerous situation.</p> <p>Severe injury or death.</p>
CAUTION	
	<p>Potentially dangerous situation.</p> <p>Light injuries or damage to the product.</p>
INSTRUCTION	
	<p>Potentially harmful situation.</p> <p>Damage to the product or to its surroundings.</p>
INFORMATION	
	<p>Indicates usage tips and other highly helpful details of information before the individual steps.</p>

3.3 Warning, mandatory and prohibitory signs used

3.3.1 Warning signs



Pictogram	Meaning	Name
	General warning sign	W001
	Electrical voltage warning	W012

Table 9 Warning signs

3.3.2 Mandatory signs



Pictogram	Meaning	Name
	General mandatory sign	M001
	Mind the manual	M002

Table 10 Mandatory signs

3.3.3 Prohibitory signs



Pictogram	Meaning	Name
	General prohibitory sign	P001
	Do not lean	P041

Table 11 Prohibitory signs

3.4 General safety instructions

Even though maximum care has been taken in the design and construction of the product and all safety-relevant circumstances have been considered, residual hazards may still exist, which have been evaluated by means of a risk assessment.

The following safety guidelines must be observed during all work on the charging station:

- Disconnect
- Secure against reconnection
- Verify absence of voltage
- Earth and short circuit
- Secure or insulate surrounding, live parts

Some BEVs require external ventilation, because when carried out indoors the charging process may lead to noxious or explosive gases being generated. This option is available for the i-CHARGE CION, please contact us for ordering.

3.5 General regulations

In general, the following safety regulations and obligations apply when handling the product:

- The product may only be operated in perfect condition.
- It is prohibited to remove, modify, bridge or bypass any protective, safety or monitoring equipment.
- It is prohibited to reconfigure or modify the product.
- Faults or damage must be reported to the manufacturer immediately. They must be remedied immediately with original spare parts.
- For any activity other than the intended use in the proximity of the product, it must be disconnected from the power supply and secured against reconnection.
- The safety instructions and operating instructions from the documentation of the components used must be observed in all cases.
- All protective, safety and monitoring equipment must be inspected and serviced regularly by the operator.
- The maintenance work can be requested from Schrack Technik GmbH and must be carried out by them or a certified i-CHARGE Partner.
- After maintenance or repair, the product may only be put into operation with all protective devices installed.

- The national safety and accident prevention regulations apply to the operation of the product.

INSTRUCTION



Malfunction of the product

Attention must be paid that the area around the product is kept clean and tidy. All objects and packing materials not required for the operation of the product must be removed from the area around the product.

INSTRUCTION



Lighting at the workplace

For maintenance, repair and calibration work, it may be necessary to equip the work area with an additional light source.

INSTRUCTION



Where to put tools

No objects or tools may be placed on the product. An exception are the tools required for assembly, which must be removed before initial operation.

3.6 Warning, mandatory and prohibitory signs on the product

Safety instructions are attached to the product and the product supplements, which draw attention to hazards / residual hazards.

The instructions of the safety marking on the product must be followed under all circumstances. If the safety marking fades or is damaged during the life of the product, it must be replaced immediately with new plates. Readability and completeness must be checked at regular intervals. From the time the signs are not immediately recognisable and understandable at first sight, the product must be taken out of service until the new plates are affixed.



Pictogram	Meaning	Name
	Electrical voltage warning (to be found on the rating plate)	W012
	Mind the manual	M002

Table 12 Pictograms on the product

3.7 Safety elements & temperature monitoring

The product is equipped with the following safety elements:

- 6 mA DC residual current detection
- Monitoring of the protective earth connection to the BEV
- Glass tube fuse for the control electronics

The charging station constantly measures the inside air temperature. If the i-CHARGE CION is installed at a location where it is directly exposed to sunlight (potential surface temperatures > 50 °C), the charging current may be reduced or charging may be paused for brief intervals to safeguard the installed components against overheating.

As soon as the charging controller finds the inner temperature low enough, charging will continue.

4 Installation/ initial operation

The following chapters describe the installation. This includes requirements as regards transportation, storage, installation site, mounting, and the initial operation.

4.1 Transportation

Usually, Schrack Technik GmbH will deliver the product to the customer.

If the product is not delivered by Schrack Technik GmbH or transported by the customer, appropriate packaging (original packaging) and a suitable carrier must be used for transportation. Mounting of the product must be carried out by a qualified electrical engineering specialist. Moving parts must be properly secured. Sensitive parts must be protected from external factors by a carton wrapping or similar material. The product must first be shut down as described in chapter 7.7.

4.2 Installation conditions

- Local contact person for the mains disconnection device in the electrical distribution board.
- A prepared, sufficiently dimensioned and fused supply line (see chapter 1.4).
- If the temperature difference between transport and installation site exceeds 15 °C, condensation may have formed. It is necessary to wait with the installation until the temperature of the charging station has reached room temperature and the condensed water has evaporated.
- Immediate initial operation without acclimatisation time can lead to damage.

4.3 Storage

The following should be considered when storing the product.

- Depending on the ambient conditions, the product must be protected accordingly.
- When stored at an ambient temperature below 5 °C, special precautions must be taken against frost damage, especially to the electrical components.
- The product must be stored in a dry place.

4.4 Installation site

- It must be ensured that the installation site is level, vibration-free and free from contamination.
- The installation site must be designed for the weight of the product. In addition to the product weight, the load caused by disconnecting and connecting (dynamics) must be taken into account.

- Mounting of the product is carried out by qualified personnel of Schrack Technik GmbH or an electrical engineering specialist.
- A prepared, sufficiently dimensioned and fused supply line (see chapter 1.4)

4.5 Mounting

WARNING



Inexpert working during the mounting process poses additional hazards.

If the product is not mounted properly, it may be damaged or may be hazardous to people and property.

- Mounting work must be carried out exclusively by a qualified electrical engineering specialist.

The following should be considered when mounting the product:

- Before setting up the product, it must be checked for completeness and transport damage. Deviations must be reported to Schrack Technik GmbH immediately.
- Later complaints cannot be considered.
- The product must be mounted securely and upright on a firm and vibration-free surface.
- Supply lines must be fused according to applicable laws and standards.

INSTRUCTION



Back-up fuse

Refer to the data sheet of your charging station or chapter 8 for the recommended back-up fuse.

If necessary, the back-up fuse must be dimensioned differently, taking into account the tripping conditions.

4.5.1 Scope of delivery

All CION charging stations EMCIONxxxx are supplied with the following accessories:

Mounting kit comprising:

- 2x ®Fischer DUOPOWER Set stainless steel
(each comprising 2 pcs. wall plug + 2 pcs. countersunk screw)
- 4x sealing washer
- 4x rubber cap
- Cable sealing glands: one piece M20, M25, M32 each
- 1x stepped sealing gland for supply line from the rear
- 4x housing screws – stainless steel

The Semipublic models with the designation ending on "EMCIONSxxx" contain the following RFID cards:

- EMCRFIDC-- 2x charge card for authorisation
- EMCRFIDCM- 1x master card for teaching additional RFID tags

The CION Pro models corresponding to "EMCIONP2xx" include the following extension:

- 1x field-attachable RJ45 plug (Art. No.: HSISR6SI3A)

4.5.2 Wall mounting and electrical connection

This chapter describes how to mount the charging station on a wall.

1. Hold the drill template (1) and a spirit level (2) against the wall.
2. Make sure the drill template (1) is level (2).
3. Mark the positions for the drill holes on the wall. If the power line is fed in from the rear, make sure to place the corresponding cut-out position on the drill template exactly over the wall outlet. Using the notches in the drill template you can draw a centre line on the wall. It will help you to align the wall box correctly when mounting it.

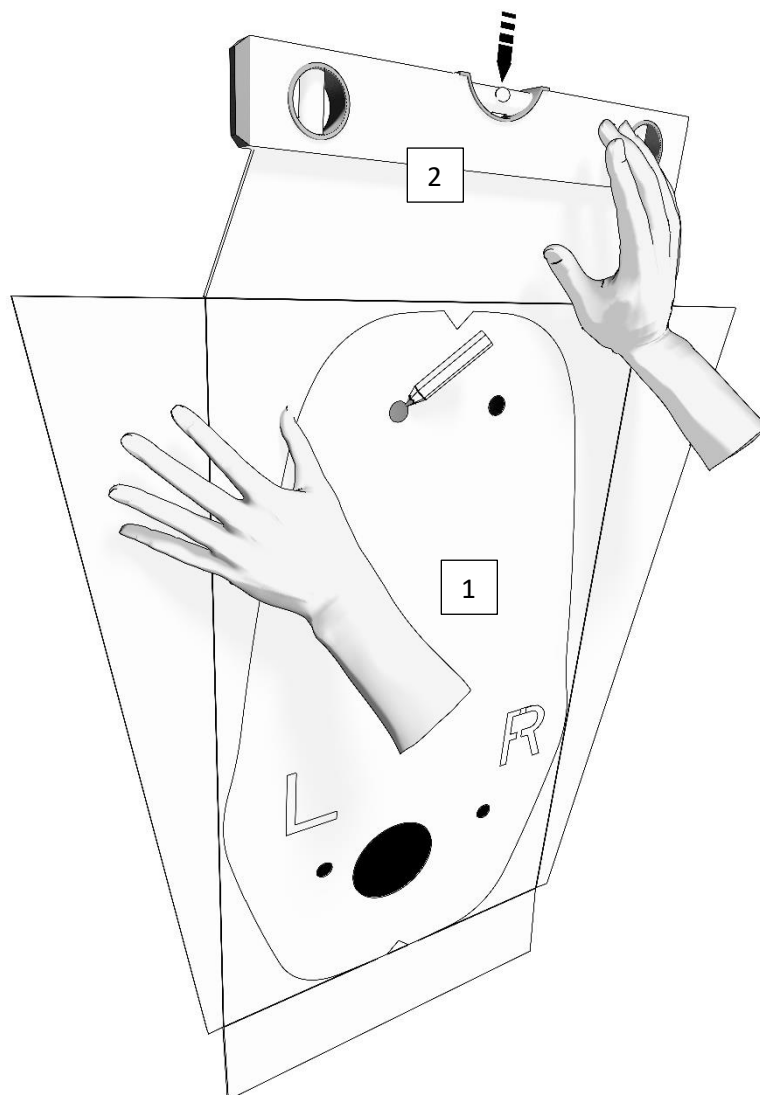

Figure 2 Positioning the drill template on the wall

4. Use a power drill (3) and a drill bit suitable for the wall to drill the four marked holes. Please mind the instructions provided with the ®Fischer Mounting Set included in the delivery.

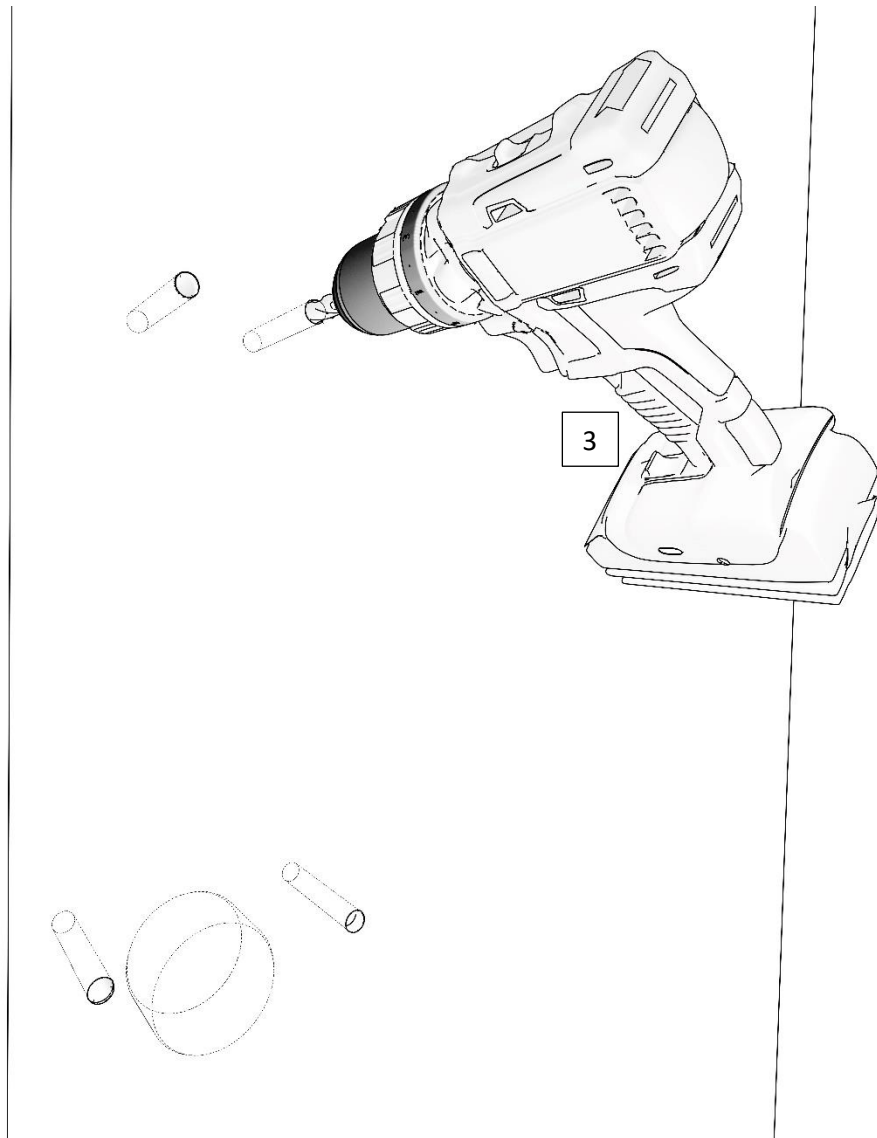

Figure 3 Drilling the holes in the wall

5. Insert the four included ®Fischer wall plugs (4) completely in the drill holes.

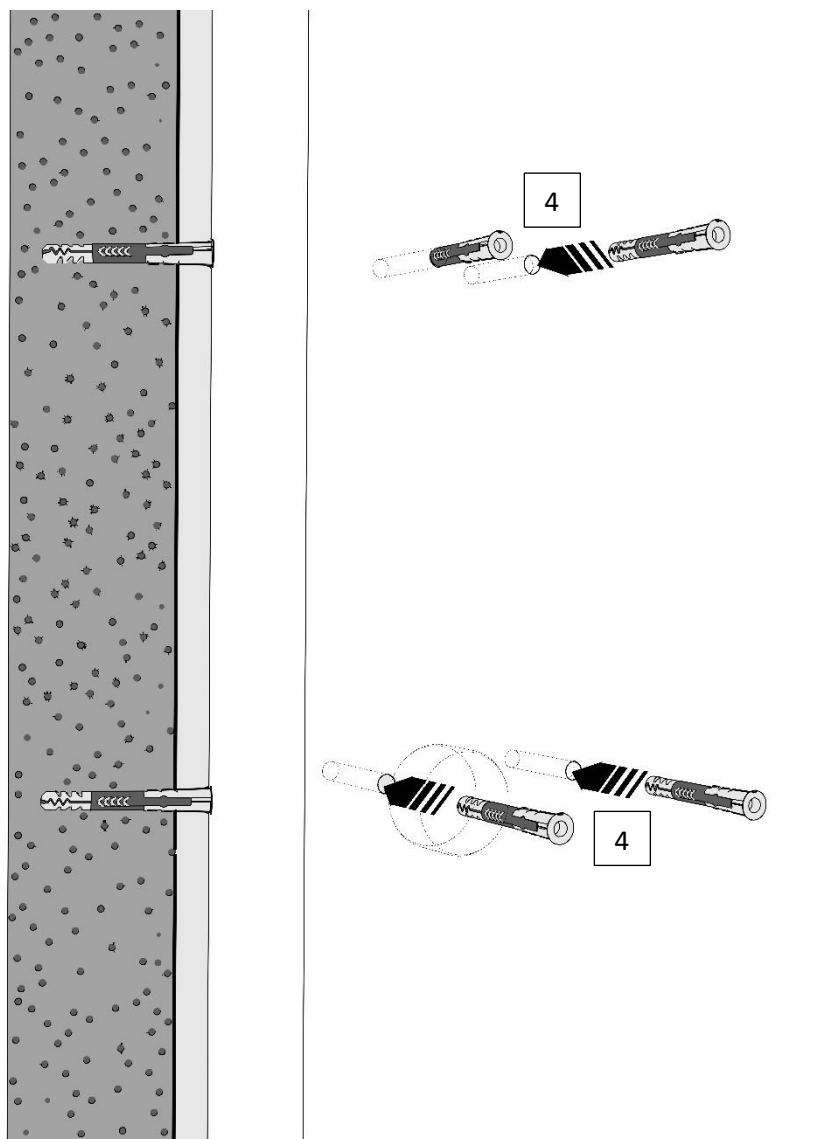

Figure 4 Inserting the wall plugs

6. Now put the CION wall box on a clean and dry surface and unscrew the four TORX T25 screws (5) with a fitting screwdriver. Make sure not to lose the screws. Best put them in the provided accessory box with the other screws.



Figure 5 Opening the cover

7. Intermediate step – cable type – note on socket:

If you are using an EMCIONxxCx model with permanently connected charging cable, immediately after lifting the cover you must disconnect the connection cable (6) of the RFID reader or the LED board.



Figure 6 Removing the connection cable

INFORMATION



Disconnecting the connection cable

For all models with a type 2 charging socket and a designation ending on EMCIONxxPx , disconnecting the connection cable is not necessary, because the retaining straps allow the installation by a single person. In this case the retaining straps, which are attached to the top and base of the housing with screws, hold the cover in place during mounting.

8. In the following step, it makes a difference whether the power feed gets inserted from the rear (7) or from below (8), depending on the local conditions. Use a step drill (9) to open the corresponding drill-out entry in the housing. Clean frayed edges of the drill holes if necessary. Make sure to remove all chippings from inside the charging station. If the power cable is fed in from below, the outer cable diameter must be measured to use the fitting cable gland (M25 or M32). If the power cable is fed in from the rear, drill the entry to M25. The sealing plug is suitable for supply lines up to 21 mm outer diameter.

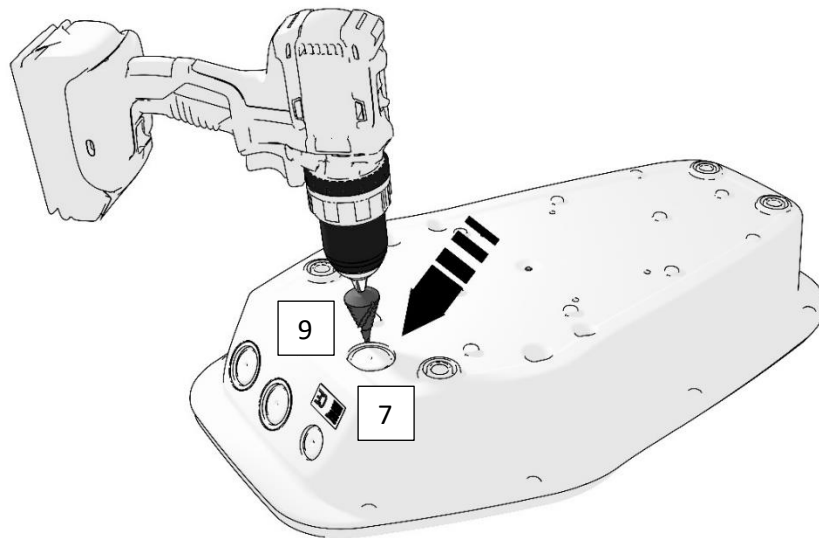
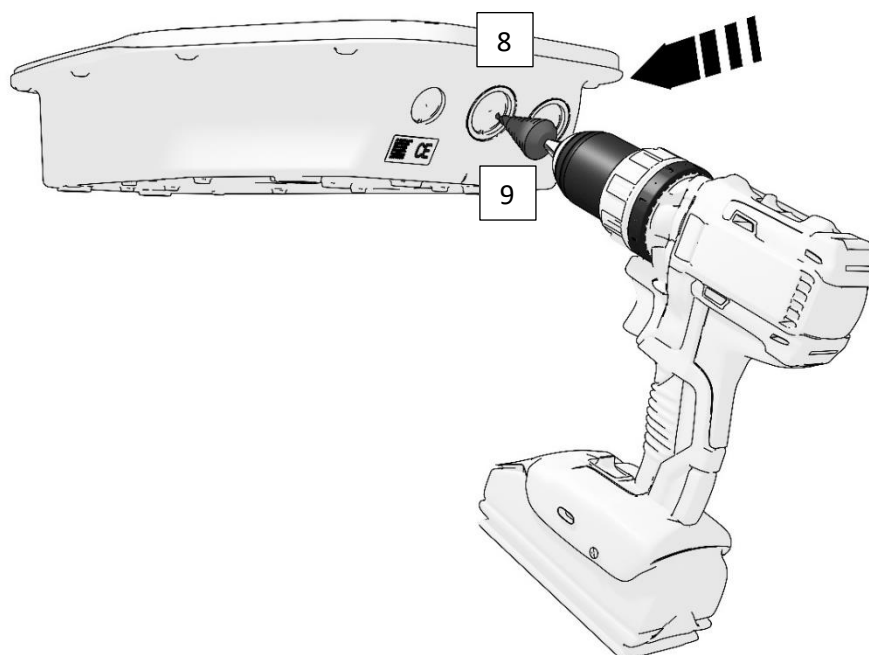

Figure 7 and 8 Drilling the cable inlets from the rear I and from below II



9. Now insert the power line (10) in the station using the corresponding cable inlet from the rear or from below.

Make sure that the cable entry is correct and complies with the applicable regulations (jacket incl. minimum cable length for proper connection).

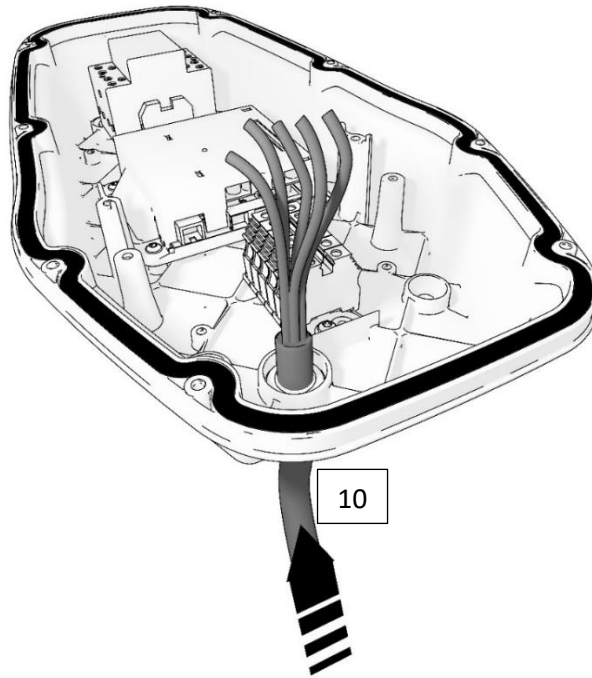
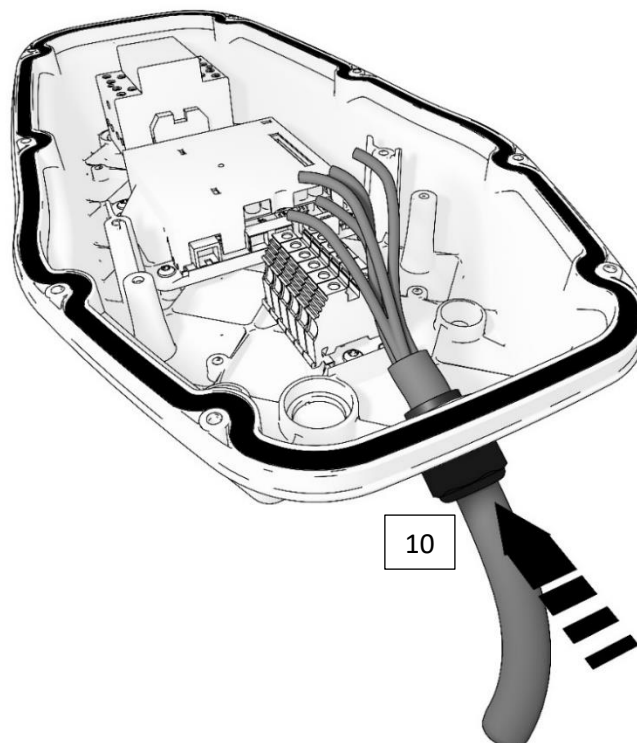

Figure 9 and 10 Inserting the feed cable from the rear I and from below II



10. Now you can attach the wall box to the wall. Follow the steps below for the correct sequence:

1. ®Fischer wall plug
2. ®Fischer screw
3. Sealing washer
4. Rubber cap

Prepare the included ®Fischer screws incl. the sealing washer for the mounting process. Hold the wall box against the wall and screw in lightly the two upper screws using a Torx T30 screwdriver. Repeat this step with the two lower screws and use the centre line drawn previously to mount the wall box straight. Now tighten the screws crosswise with a torque of about 3 Nm. In the last step put the rubber caps over the screw heads. These rubber covers are necessary to achieve appliance class II.

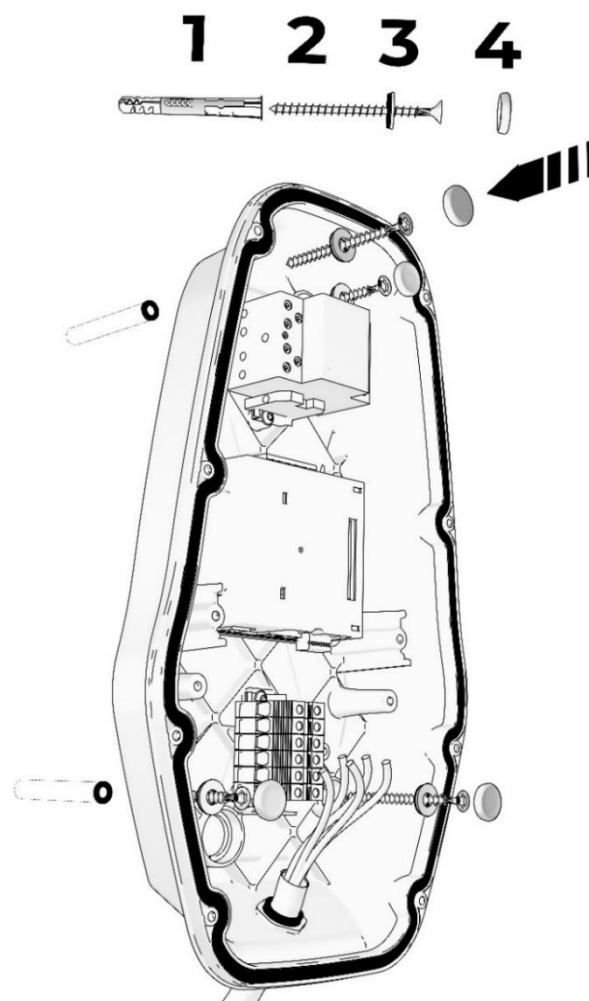

Figure 11 Mounting the wall box on the wall

11. Now connect the power cable (11) to the terminal block. Mind the local conditions and the applicable technical regulations for power connections (TAEV in Austria). Connect the earth cable (green/yellow), the neutral conductor (blue) and the phases L1, L2 and L3 using a maximum torque of 1.2 Nm.

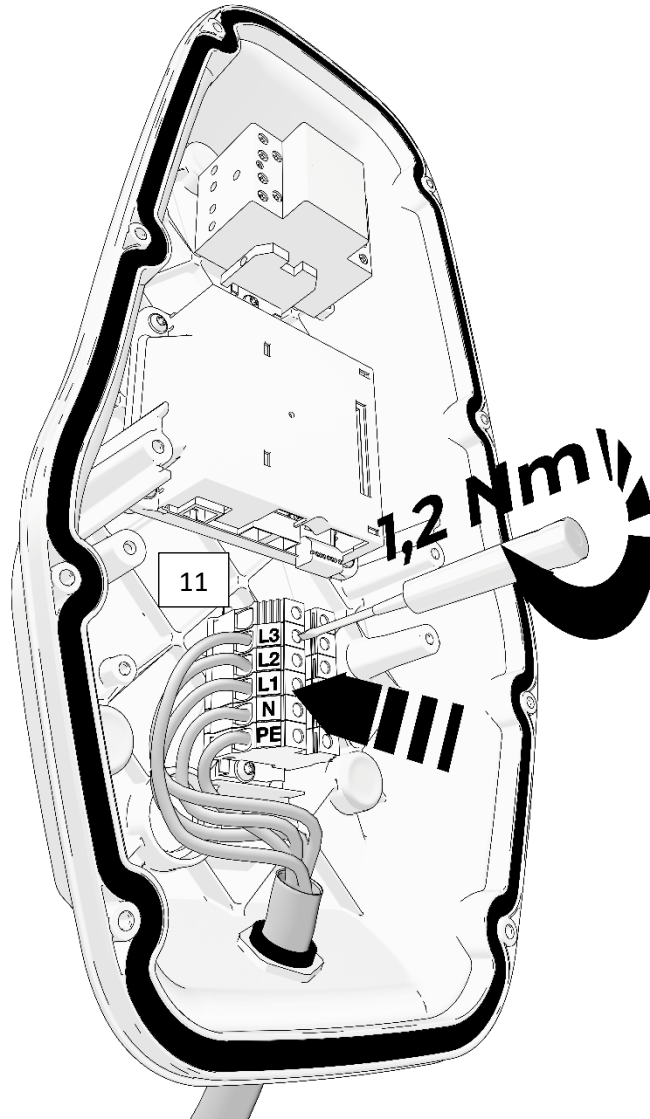

Figure 12 Connecting the feed to the terminal block - 3-phase connection

INFORMATION



Single phase connection

Every CION model can and may also be connected to a single phase. To do so, leave the terminals for L2 and L3 empty - see (12). However, remember to tighten the screws of the empty terminals nevertheless. The DIP switches of the charging controller must be set to match the back-up fuse (see chapter 0).

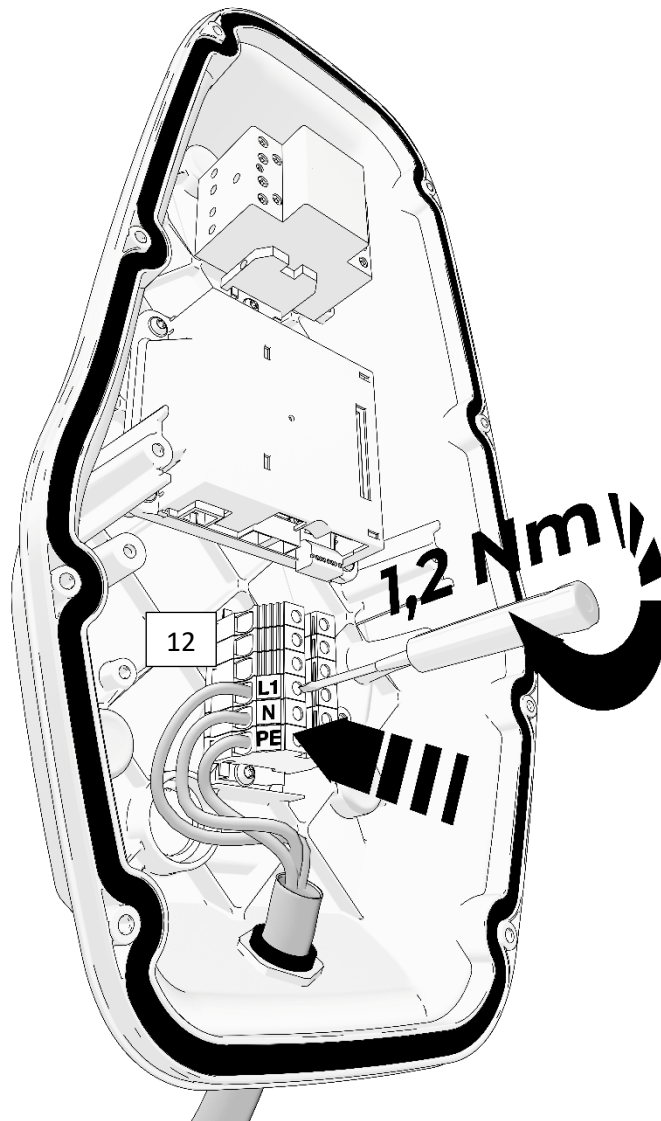

Figure 13 Connecting the feed to the terminal block - 1-phase connection

12. Check the correct positioning of the feed line (13). The feed line must not run across or touch the terminal block (14). This applies both to feed-ins from the rear and from below.

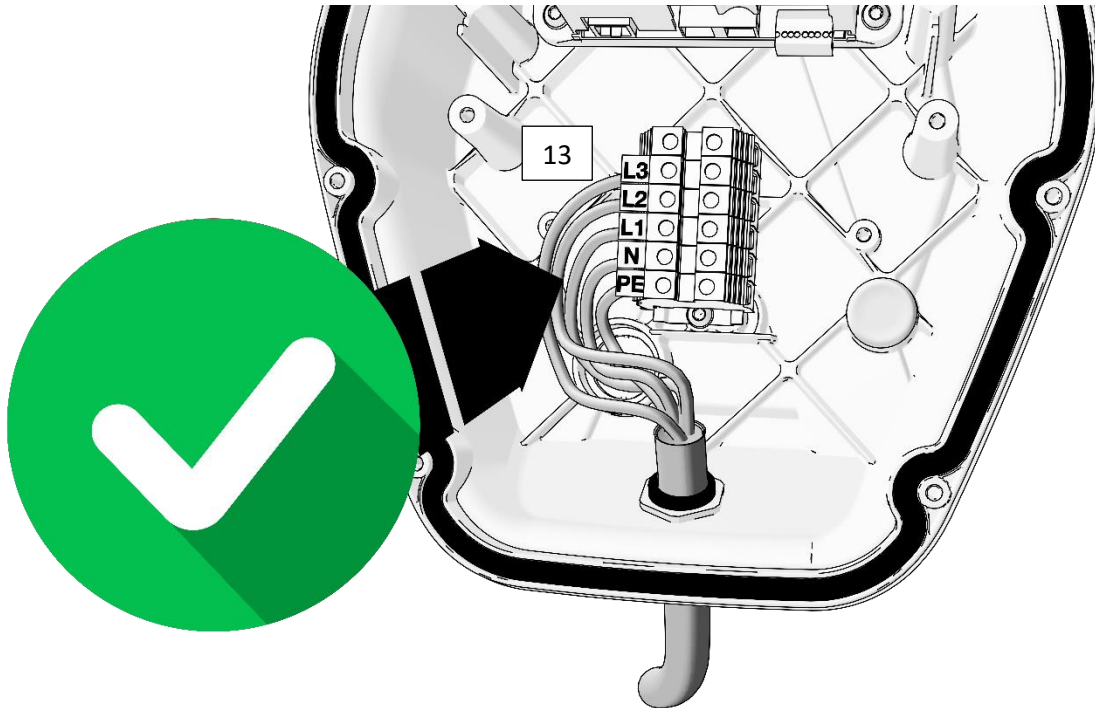

Figure 14 Checking the correct feed line position - correct

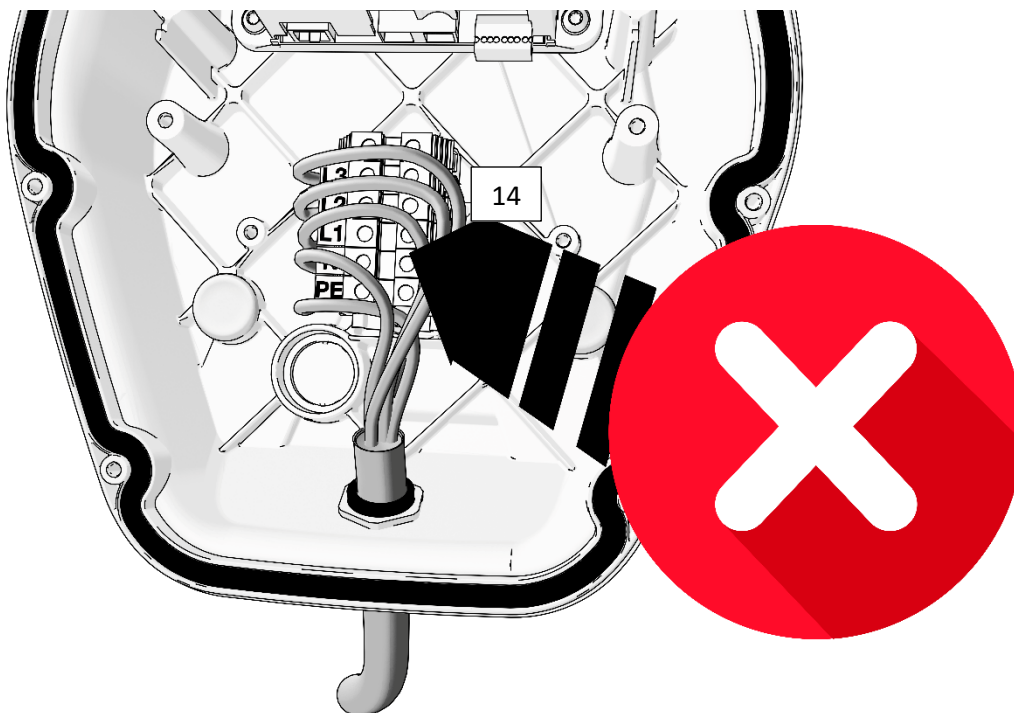

Figure 15 Checking the correct feed line position - incorrect

13. If the power line is fed in from below (15), make sure the connection is tight and secure. The connections must be properly attached and hand tight. If the power line is fed in from the rear, make sure the stepped gland sits correctly, so that it prevents the ingress of water.

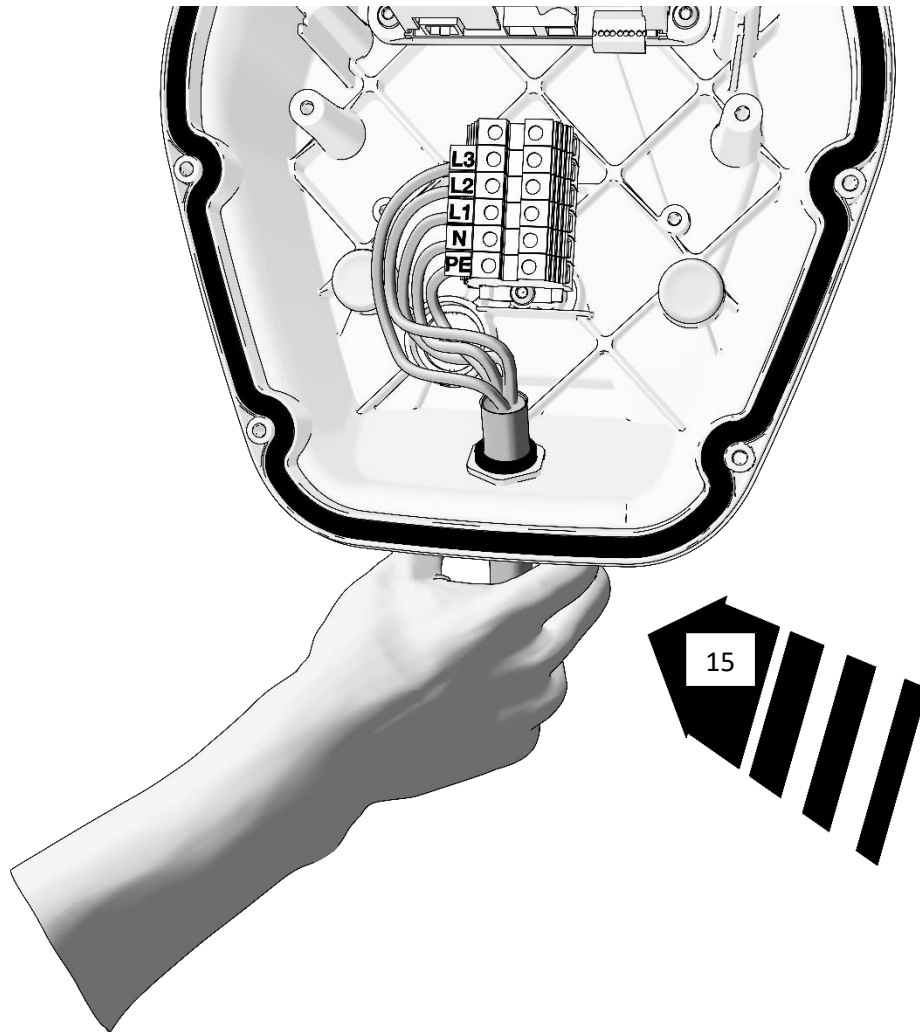

Figure 16 Checking the cable attachment

14. Intermediate step – cable type:

Complementary to step 7, in this step you reconnect the connection cable (16) of the RFID reader or the LED board.

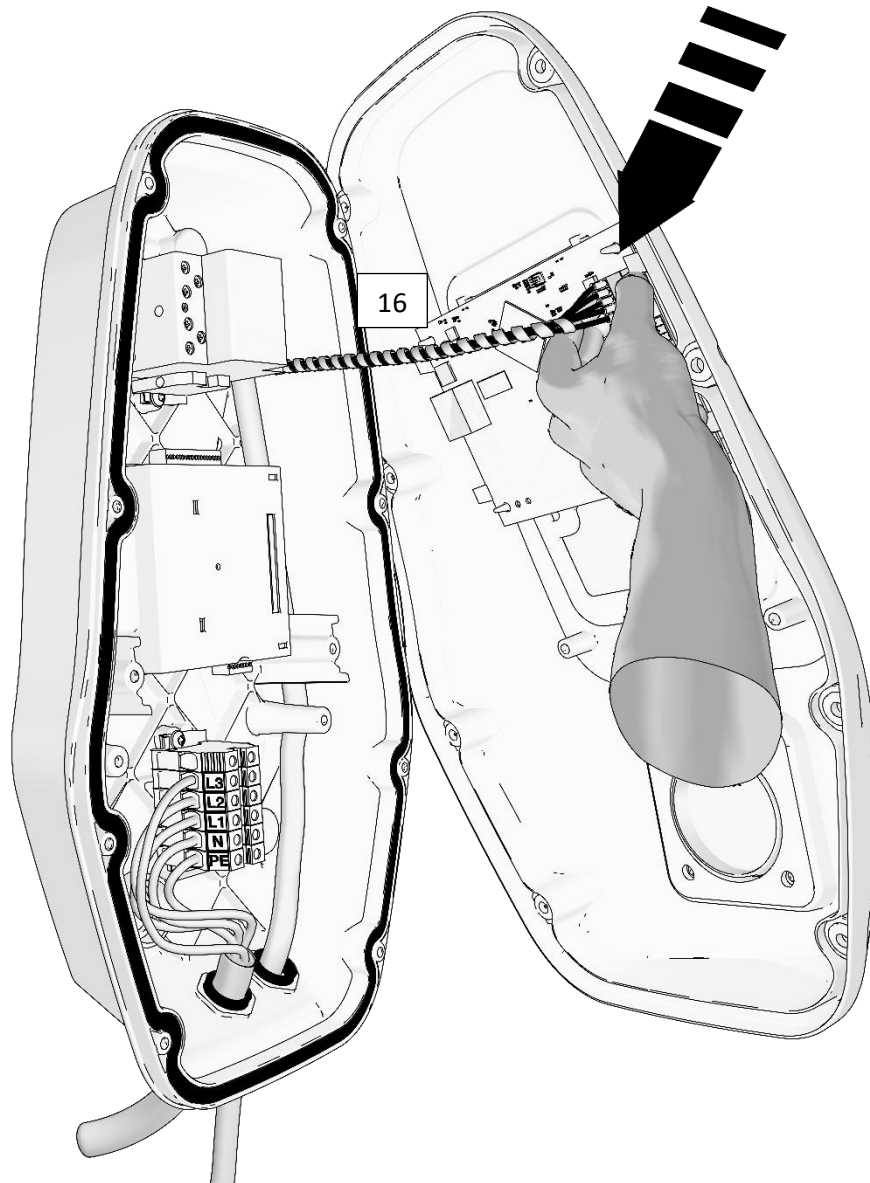

Figure 17 Connecting the connection cable (RFID reader, LED board)

15. Finally, screw all 8 stainless steel plastic screws (5) of the cover into the openings provided. Make sure that the screw connection is evenly distributed when screwing on and do not exceed a maximum tightening torque of 3 Nm.



Figure 18 Mounting the cover

4.5.3 Installation on mounting pole

Mounting the charging station on one of the poles available as accessory - EMCIONS1 for a single CION or EMCIONS2 for a double version - is also possible. The mounting poles are made of rugged stainless steel V2A and designed for a long service life. For more information, please access the articles on our website at www.schrack.com/services/cion-docu.

4.6 Installation regulations

- Observe the applicable local electrical installation regulations, fire prevention measures and accident prevention regulations.
- The charging station must not be installed in hazardous areas (EX environment).
- Mount the charging station in such a way that it is not in the direct path of people and no one can trip over the plugged in or permanently connected charging cable, or that the charging cable does not block or cross pavements.
- Do not install the charging station in places where it is exposed to ammonia or ammonia gases (e.g. in or near stables).
- The mounting surface must have sufficient strength to withstand the mechanical stress.
- Do not install the charging station in places where falling objects (e.g. hanging objects) might damage the appliance.
- According to the product standard, the charging station, in particular the type 2 socket, must be positioned at a height between 0.4 m and 1.5 m.
- It is recommended to mount the charging station (height of socket or parking bay) at a height of 1.2 m. It should be noted that national regulations may restrict the height.
- The appliance must not be exposed to direct water jets (e.g. from neighbouring manual car washes, high-pressure cleaners, garden hose).
- If possible, the appliance should be installed protected from direct rain to avoid icing, damage by hail or similar.
- The appliance should be mounted away from direct sunlight to avoid reducing the charging current or interrupting the charging process due to excessive temperatures in components of the charging station.

4.7 Initial operation

Initial operation of the product must be carried out by qualified personnel of Schrack Technik GmbH or an electrical engineering specialist. All applicable standards and laws must be observed in the process.

4.8 Operator handover

The product is handed over to the customer after initial operation. The handover is effected with the signing of the test report. When the qualified personnel of Schrack Technik GmbH or an electrical engineering specialist hands over the system to the customer as ready for operation, the responsibility is also transferred to the customer. Test reports must be prepared in accordance with the requirements of EN 8101.

5 Operation

After the mounting and the initial operation your CION wall box is ready for charging your BEV. Depending on the i-CHARGE CION model used it is possible that the modes "Plug and Charge", "Local Authentication with Authorisation" or "Online Authentication via Back-End" are supported. The following describes the models with their different operating elements and display elements.

5.1 Operating elements

The operating elements vary depending on the model and version and are described in the following. In particular, differentiation will be made between the models with charging socket and charging cable.

The RFID reader field and the meter display window are possible with both versions, with or without cable. Charging at the Semipublic and Public stations is only possible after authentication. To do so, an RFID card must be held against the RFID reader field (for details, see chapter 5.2.2.2). On the meter display window, the end customer at publicly accessible CION charging stations can check the meter reading of the MID calibrated meter before charging begins and at the end. In this way one can draw conclusions about the amount of energy charged.

INFORMATION	
	<p>RFID Standard</p> <p>The charging station contains an RFID reader which can process all RFID media of the ISO 14443A and 14443B standards.</p>

5.1.1 Charging socket

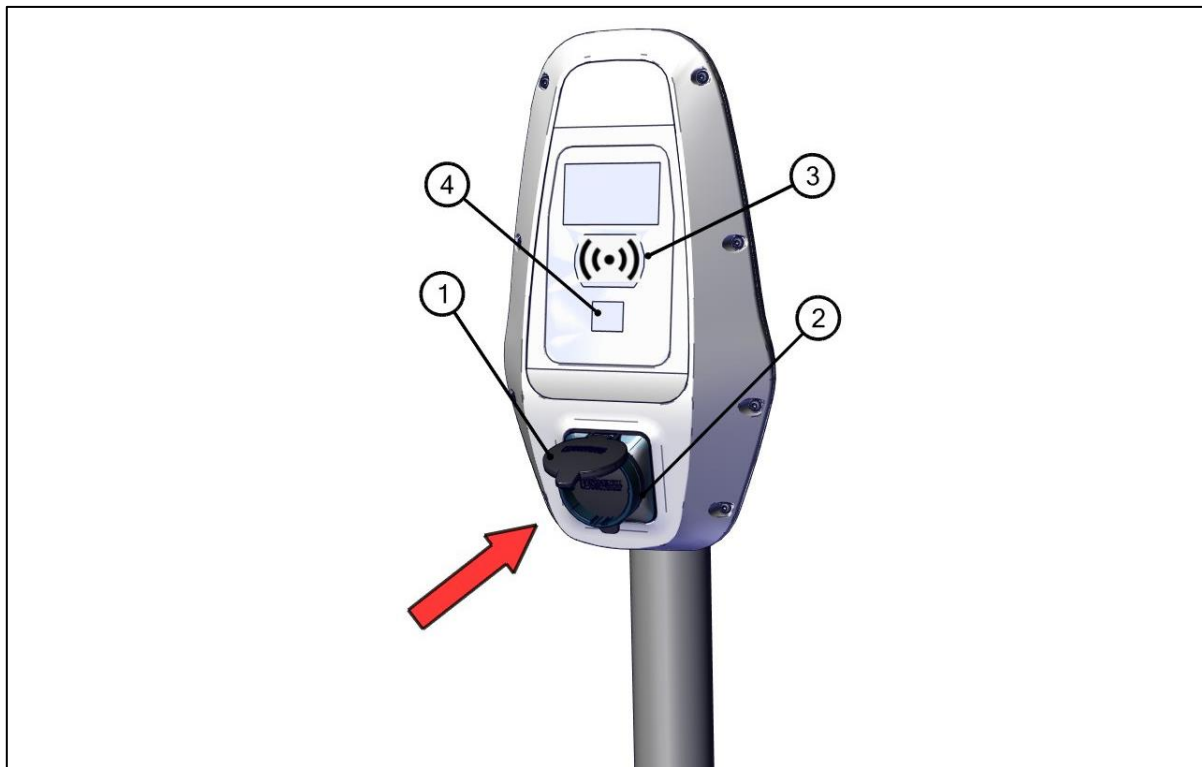

Figure 19 Charging socket

No.	Description	No.	Description
1	Lid	3	RFID reader field
2	Charging socket	4	Meter display window

Plugging-in:

Lift the lid (1) and plug in the charging cable as straight as possible into the charging socket (2). Then connect the other end of the charging cable to the car. If you experience any kind of problems while doing so, please check for dirt or other objects which might prevent a correct connection. Also, please mind the manufacturer instructions for your BEV.

Unplugging:

To end charging or after charging is terminated automatically, first disconnect the charging cable from the car. To do so, it may be necessary to unlock the car again or to press an unlock button (if necessary, please consult the operating manual of the car). Then disconnect the plug from the charging station.

INSTRUCTION	
	<p>Only use certified and faultless charging cables in accordance with the manufacturer's specifications for your BEV. Certified charging cables are also available from Technik GmbH.</p>

INFORMATION	
	<p>Automatic reduction of the charging current</p> <p>If a charging cable is connected which can transmit less power than the maximum power of the charging station, the station automatically reduces the charging current - in this case the connected charging cable is the limiting factor.</p> <p>Example: If you connect a 16 A (11 kW) charging cable to a 22 kW charging station, the charging station automatically reduces the charging current to 16 A and thus the charging power to 11 kW.</p>

5.1.2 Charging cable

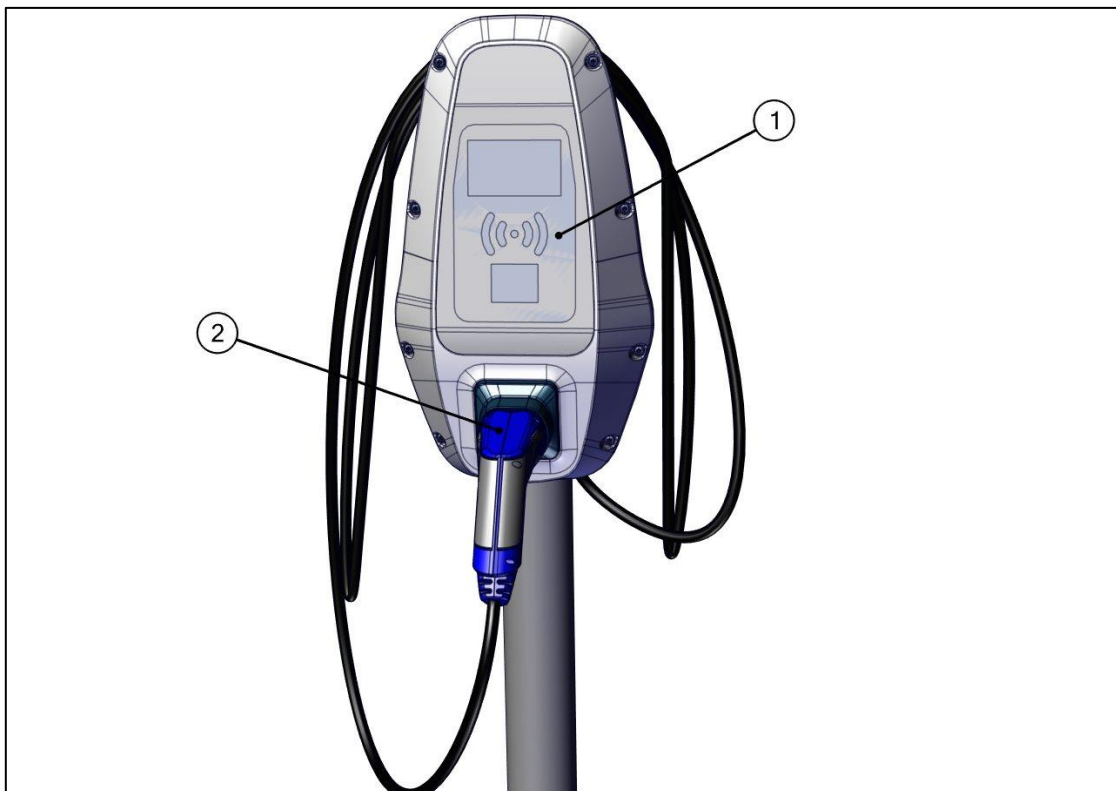

Figure 20 Charging cable

No.	Description	No.	Description
1	RFID reader field	2	Charging cable

Plugging-in:

Remove the charging cable (2) from the holder. To do so, lift the plug of the charging cable at the front and then pull it out of the holder. Then connect the charging cable to the car. If you experience any kind of problems while doing so, please check for dirt or other objects which might prevent a correct connection. Also, please mind the manufacturer instructions for your BEV.

Unplugging:

To end charging or after charging is terminated automatically, disconnect the charging cable from the car. To do so, it may be necessary to unlock the car again or to press an unlock button (if necessary, please consult the operating manual of the car). Afterwards, the charging cable can be reattached to the plug holder. To do so, the charging cable is inserted in the holder and the plug is pushed downward at the front. This securely fastens the charging cable in the holder and puts it in parking position.

5.2 Display elements – LED status display

All CION charging stations are equipped with an LED display which visualises the current status. Differentiation is made between CION Home with LED dots and the CION Semipublic/Public with LED RFID waves. The difference of cable or socket is not relevant for the following.

5.2.1 CION Home (EMCIONHxxx)

5.2.1.1 Charging station ready

The charging station is in stand-by mode and is ready for charging. The five LEDs are constantly green.



Figure 21 Home - Stand-by operation

5.2.1.2 Charging in progress

Connect the card with the charging station as described in chapters 5.1.1 or 5.1.2. The LED colour changes from green to blue. A clearly audible switching can be heard from the wall box and the charging begins.

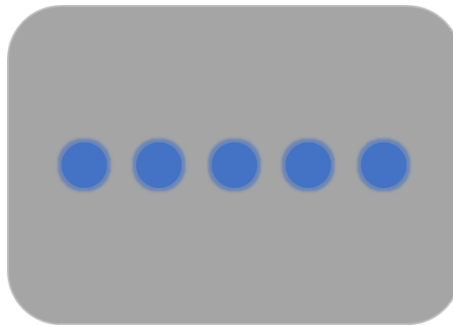

Figure 22 Home - Connecting the BEV

5.2.1.3 Charging complete

As soon as the BEV is fully charged or the charging process was paused for some other reason (higher-level charge management puts the charging station to a charging pause - e.g. photovoltaic charge control), the display changes from a steady blue light to a flashing blue light.

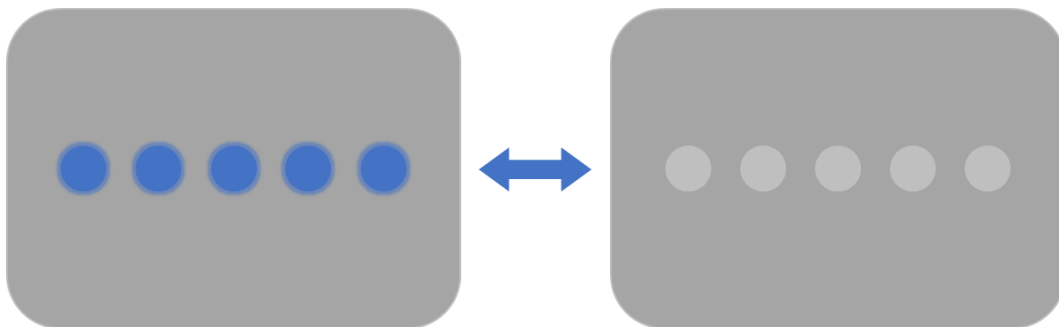

Figure 23 Home - Charging complete

5.2.1.4 End charging

To end charging unplug the charging cable properly (see chapter 5.1.1 or 5.1.2). The colour of the LED display changes back to steady green (see chapter 5.2.1.1).

5.2.1.5 Error

If the charging station detects an error, this is displayed by the LED glowing red. Possible errors can be: charging cable defective, DC residual current detection has tripped, or other errors. Errors can be resolved by unplugging the cable and then plugging it in again. If the error persists, please contact Schrack Technik GmbH or a certified i-CHARGE Partner.

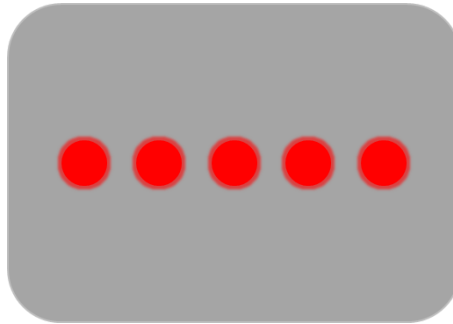

Figure 24 Home - Charging error

5.2.1.6 Charging paused

If the charging station currently pauses charging, the display glows yellow. This may be caused by an upstream system (photovoltaic system or smart home - see chapter 6.1.1) or in the event of overheating.



Figure 25 Home - Charging paused

5.2.2 CION Semipublic (EMCIONSxxx)

INFORMATION	
	<p>Depiction of the LED pattern sequence</p> <p>The sequence of the LED patterns must be read starting with image 1 (top left) and consecutively up to image 8 or lower (bottom right). This sequence repeats several times until the user or the BEV sets an action. Sometimes images can be skipped in the animated patterns shown.</p>

5.2.2.1 Charging station ready/ stand-by operation

The charging station is in stand-by mode and is ready for charging. Now connect your BEV.



Figure 26 Semipublic - Ready

5.2.2.2 Waiting for authentication

The BEV was correctly connected and identified. The charging cable is locked and the charging station is waiting for an assigned RFID medium to initiate charging. To do this, hold a trained charging card up to the reader.

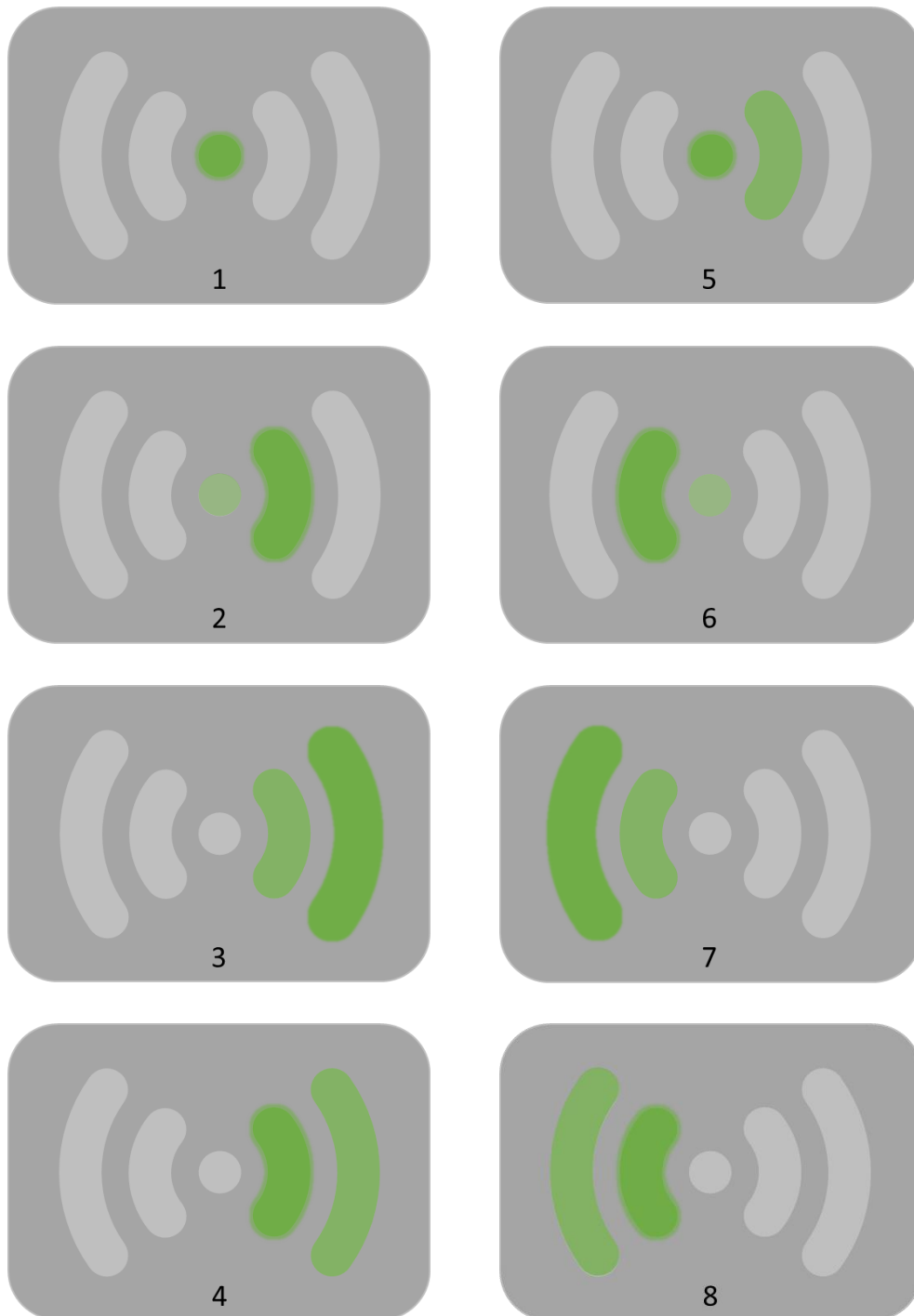

Figure 27 Semipublic - Authentication

5.2.2.3 Charging in progress

The authentication medium was correctly identified and the charging was started. The LED glow pattern has changed its colour from green to blue – charging was started with a clear one-time switching in the charging station. In this case the blue LED bars are visibly "rising", which indicates a correct charging process.

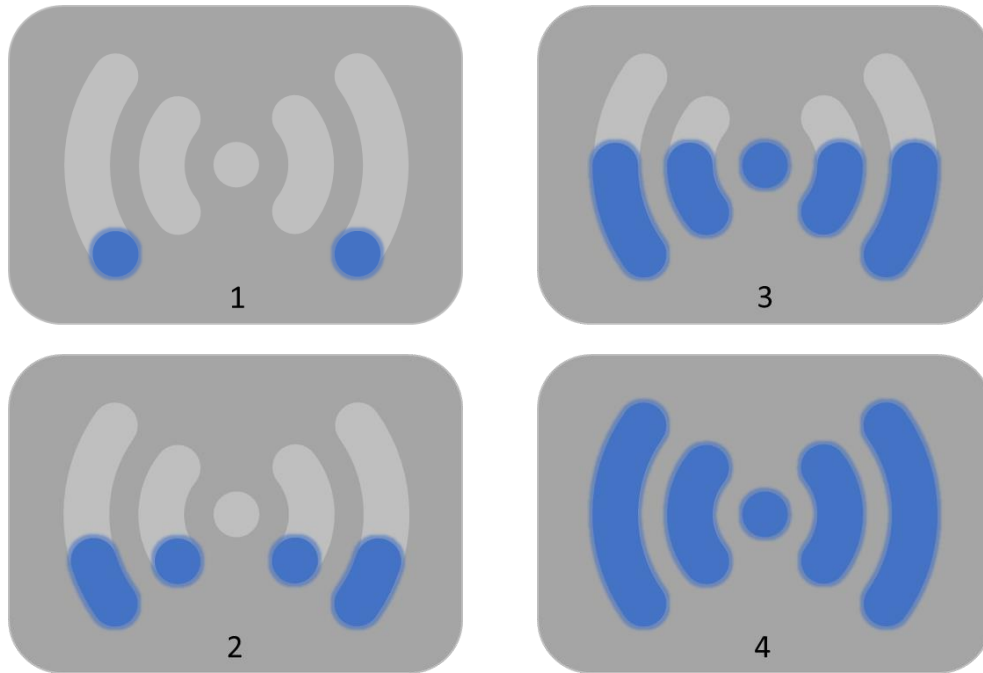

Figure 28 Semipublic - Charging in progress

5.2.2.4 Charging complete/paused

The charging was correctly ended by the BEV or by the charging station. The outermost RFID arcs pulsate, looking stronger and weaker interchangeably.

The charging station also shows this glowing signal if it currently pauses charging. This may be caused by an upstream system (photovoltaic system or smart home [see chapter 6.1.1]) or in the event of overheating.

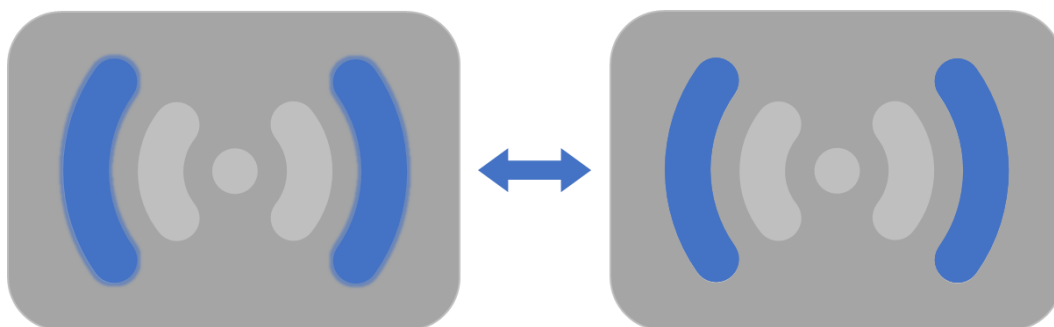

Figure 29 Semipublic - Charging complete/paused

5.2.2.5 Teaching charge cards

Holding the master card against the RFID reader puts the charging station in teach mode. The LEDs have changed to white and display the glow pattern as shown in the images 1 – 6 below. It is now possible to hold other RFID media against the reader in order to teach them. A total of up to 75 different RFID media can be stored in the charging station.

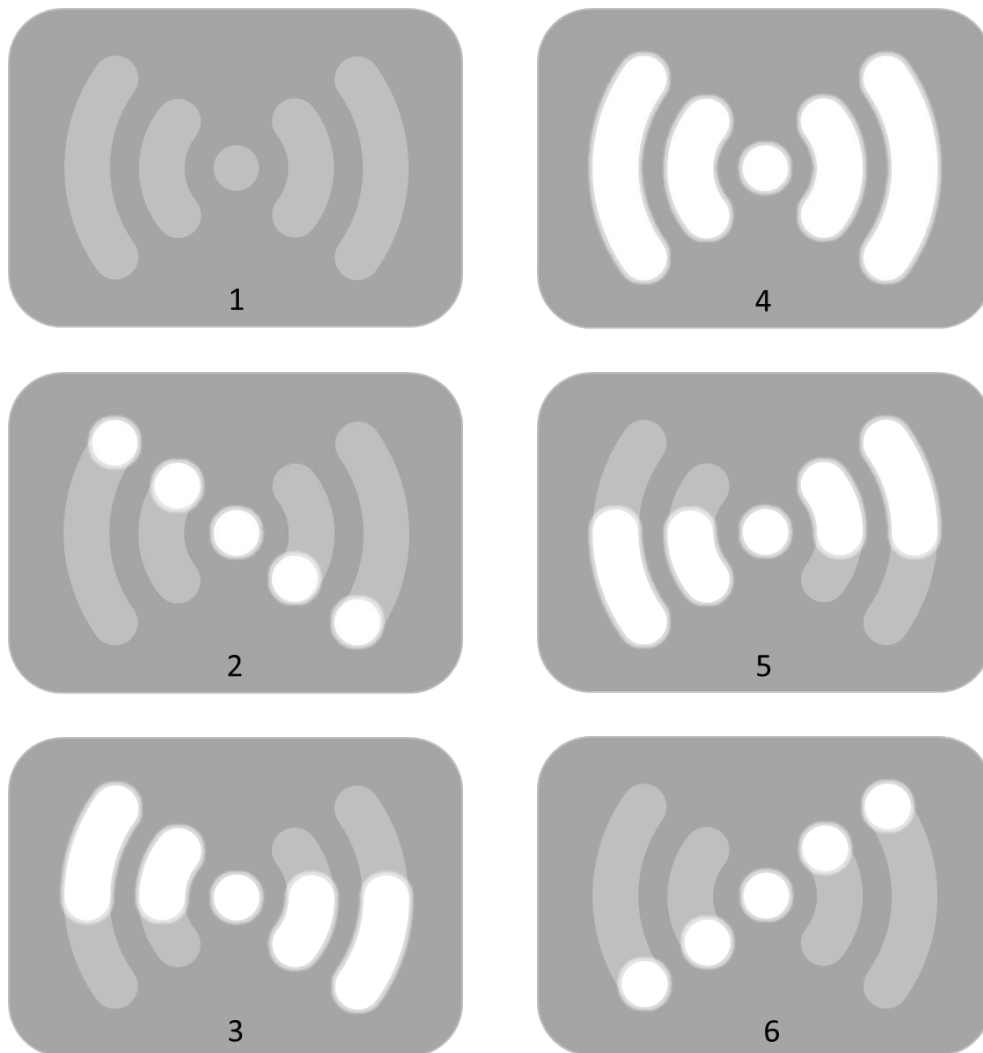

Figure 30 Semipublic - Teaching a charge card

INFORMATION	
	<p>The charging station must be on stand-by operation (5.2.2.1) to enter teach mode.</p> <p>While a charging is in progress or during other operating modes the teach mode is locked.</p>

After the charge card has been successfully trained the following glow pattern appears.

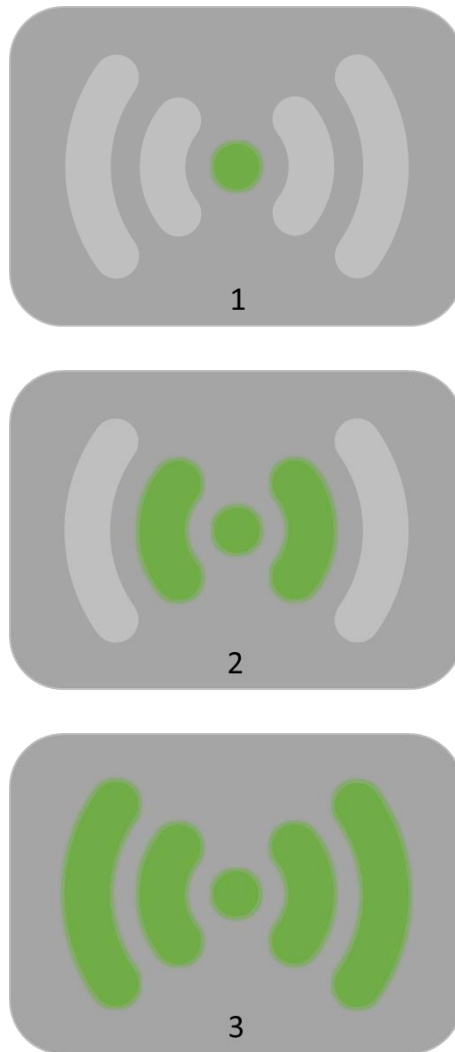

Figure 31 Semipublic - Teaching a charge card completed

INFORMATION	
	<p>Charge card already trained</p> <p>If a charge card was already trained earlier or is not accepted because of a non-compatible RFID standard, the charging station does not show this pattern but continues to display the white teach mode.</p>
INFORMATION	
	<p>Deleting the master card</p> <p>If the associated master card has to be deleted, it is necessary to open the charging station. This activity must exclusively be carried out by Schrack Technik GmbH or certified i-CHARGE Partners. Please contact Schrack in case of any questions.</p>

5.2.2.6 Error

If the charging station detects an error, this is displayed by a red-glowing LED running pattern. Possible errors can be: charging cable defective, DC residual current detection has tripped, or other errors. Errors can be resolved by unplugging the cable and then plugging it in again. If the error persists, please contact Schrack Technik GmbH or a certified i-CHARGE Partner.

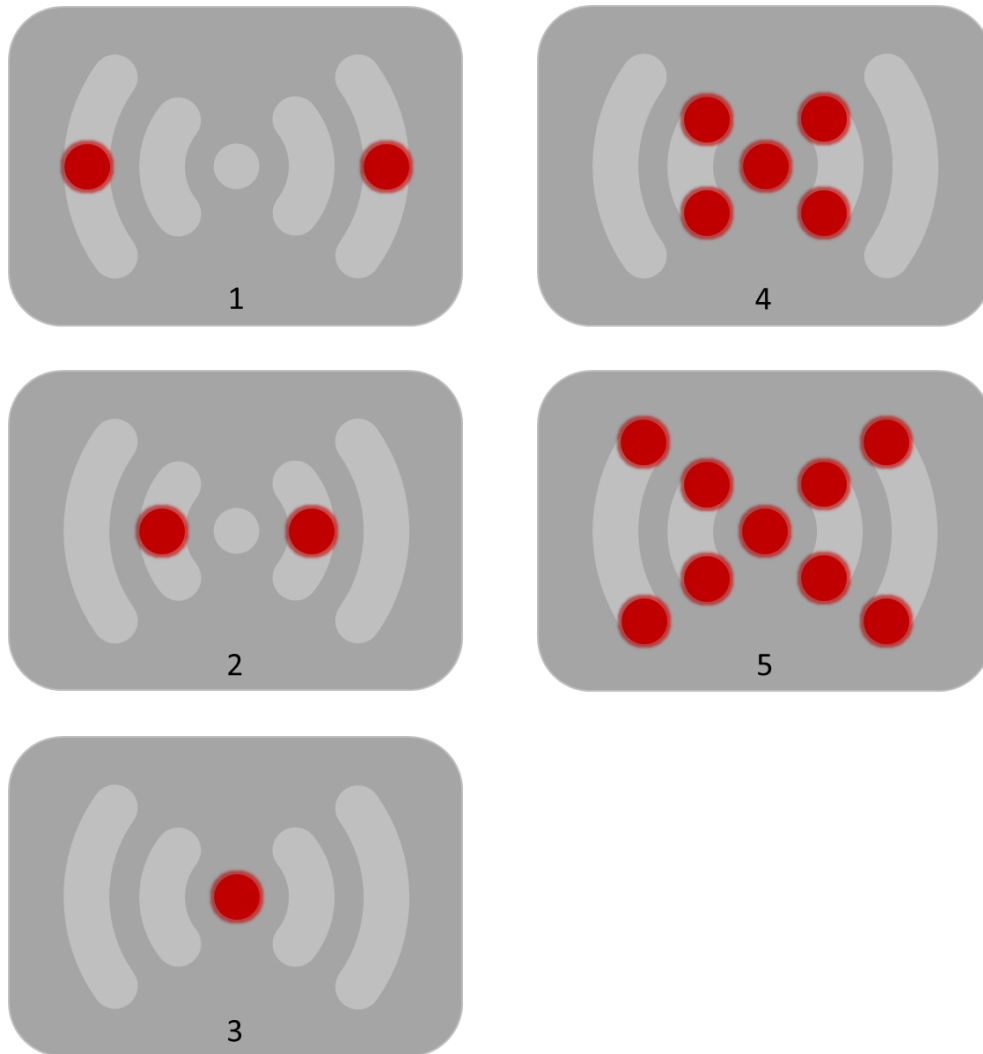

Figure 32 Semipublic - Error message

5.2.3 CION Pro (EMCIONP2xx)

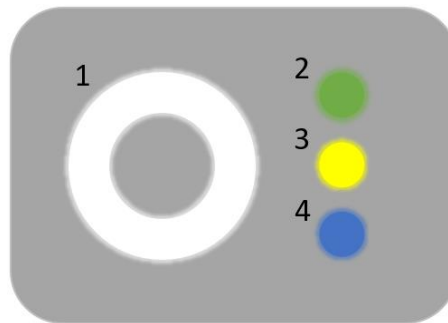

Figure 33 Pro status LEDs

LED	Status	
1	On in parallel with 3	Authentication in progress
2	Permanently on	Charging station ready - no vehicle connected
	Flashing slowly	Charging station ready - vehicle connected
3	Permanently on	Charging station reserved - no vehicle connected
	Flashing slowly	Charging station reserved - vehicle connected
	Flashing fast	Waiting for authorisation
4	Flashing slowly	Charging in progress
	Flashing fast	Charging station authorised - no vehicle connected
2,3,4*	Flashing fast	Authorisation rejected / error

Table 13 Pro status LEDs explanation

6 Configuration

6.1 Configuration of charge controller for Home and Semipublic models

The Home and Semipublic models are distinguished visually by different membranes (LED dots, LED waves) and are designed differently on the inside. The DIP switch on the charge controller allows additional options to be activated.

- 0 – 10 V PV control
- Modbus operation

The following overview explains the different DIP switch settings.

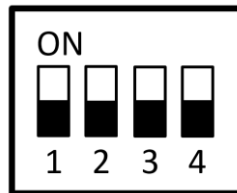





Figure 34 DIP switch charge controller Home & Semipublic

1	2	Operating mode
ON	ON	All trained charge cards and the master card will be deleted. A new master card can be trained
OFF	ON	Normal operation (+ 12 V DC on input E3) Opt. 0-10 V interface "Mode 1" (see chap. 6.1.2.1)
ON	OFF	Normal operation (+ 12 V DC on input E3) Opt. 0-10 V interface "Mode 2" (see chap. 6.1.2.1)
OFF	OFF	Bus operation for RS485 Modbus RTU - Inputs E1 and E3 are ignored
3	4	Maximum charging current
ON	ON	32 A (only EMCION22xx for 22 kW max.)
OFF	ON	20 A (only EMCION22xx for 22 kW max.)
ON	OFF	16 A
OFF	OFF	13 A (read from configuration memory (default: 13 A))

Table 14 DIP switch settings charge controller Home & Semipublic

INSTRUCTION	
	<p>DIP switch modification</p> <p>After a modification of the DIP switch configuration the charging station must be restarted. This implements the new parameters.</p>

INFORMATION	
	<p>Charging authorisation on the charge controller</p> <p>During normal operation charging is authorised either via RFID reader OR +12 V DC at input E1. The charging station automatically selects whether it is a probing or switching impulse.</p> <p>The "Plug and Charge" mode can be established by setting inputs E1 and E3 permanently on +12 V DC.</p>

INFORMATION	
	<p>Selecting the charging current</p> <p>The charging station regulates the maximum charging current for the BEV. Depending on the battery parameters the BEV determines itself how much charging current it will absorb.</p>

6.1.1 12 V DC actuator (external activation)

This actuator allows the charging station to be activated by outside systems. These may include e.g. external activation via existing RFID systems, timed activation, key switches or buttons, etc.

For enabling this function, the existing connection at input E1 must be adapted accordingly (only for EMCIONxxx-). Then the external activation can be connected to input E1. Please contact us for further details.

INFORMATION	
	<p>Charging authorisation at E1</p> <p>+12 V DC at input E1 ... charging authorisation is active</p> <p>0 V DC at input E1 ... charging authorisation is not active</p> <p>The +12 V DC signal can be either picked up from the power supply unit of the charging station or supplied externally, provided the ground potential is also transferred.</p>

6.1.2 Integration of photovoltaic & smart home systems

The charging station has two interfaces which allow an intelligent charging current selection. The station can be controlled using a 0 – 10 V interface and RS485 Modbus. With this integration the BEV can be charged with the surplus from a photovoltaic system.

6.1.2.1 0-10 V interface

The voltage signal at this interface transforms the charging current to be used for charging the BEV. The minimum charging current is set to 6 A which is standardized. The charger has two programmable modes, which defines the behaviour of a target charging currents below 6 A.

Mode 1: Charging is paused if target charging current is below 6 A.

Mode 2: Charging is continued at minimum charging current (6 A) if target charging current is below 6 A. It will also be continued if target current is 0 A or there is no signal at E3 at all.

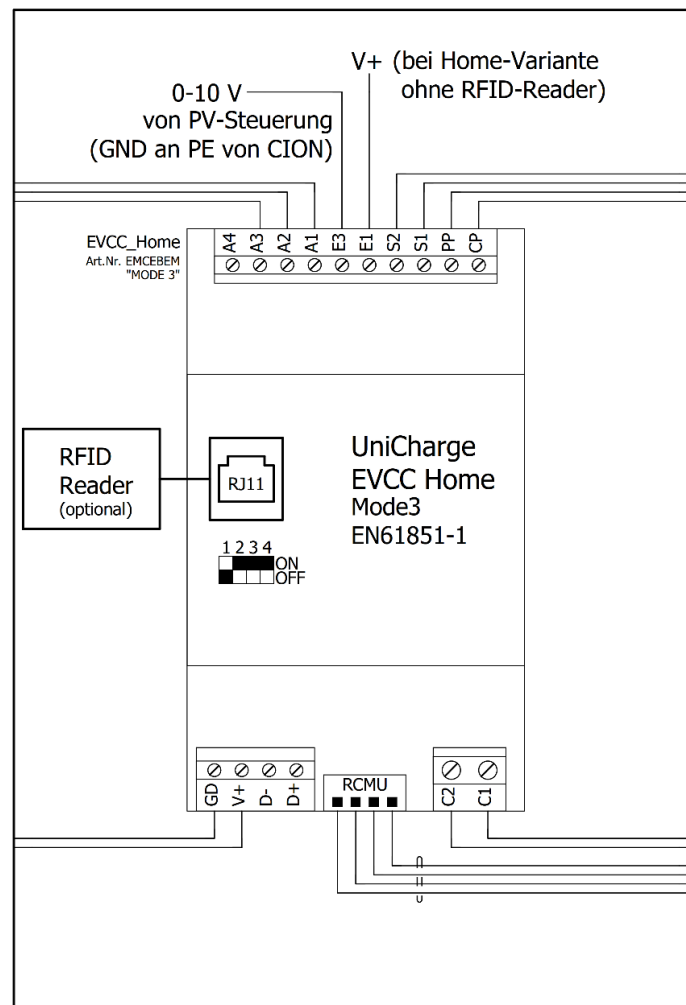



Figure 35 Charge controller schematic 0-10 V interface

INFORMATION	
	<p>Potential connection between control cable and charging station</p> <p>The earthing of the control line must be connected to the earth connection of the charging station. The control signal between 0 and 10 V is present at input E3.</p>
INFORMATION	
	<p>Transformation ratio of the 0-10 V interface</p> <p>Each 1 V step results in a 6 A linear increase of the charging current. For example, if a voltage level of 2.2 V is present at input E3, the BEV will be charged with a charging current of 13.2 A (2.2 V x 6 A/V).</p>

6.1.2.2 RS485 Modbus RTU

The Modbus RTU Interface allows to connect both photovoltaic and smart home systems.

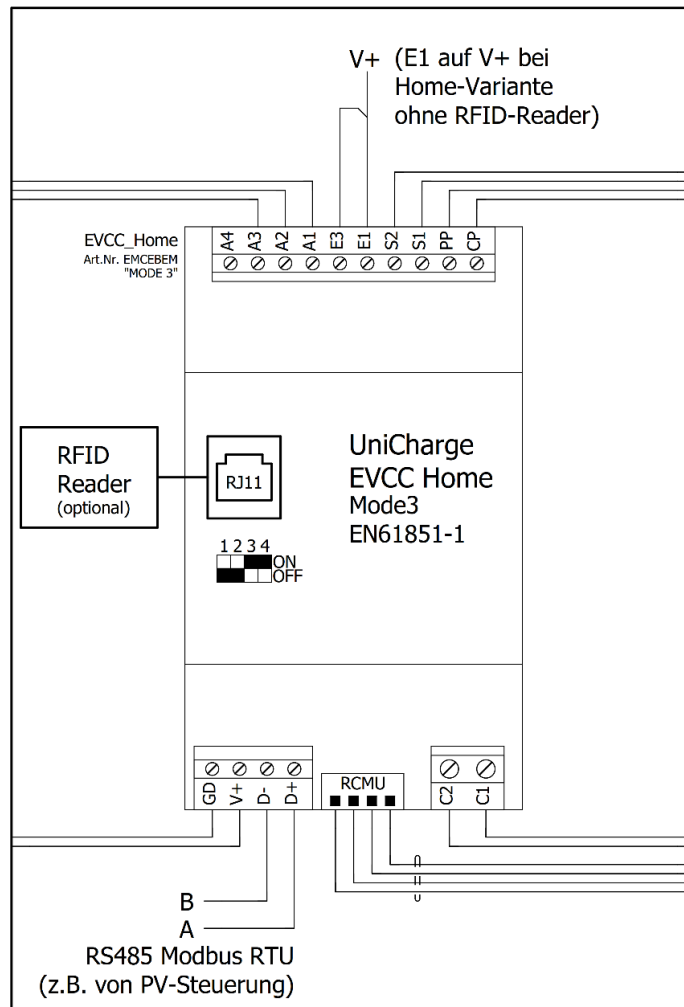

Figure 36 Charge controller schematic Modbus RTU

INFORMATION



CAT cable - shielding

For data transfer earthing the CAT cable shielding is not required.

The following parameters must be set and read via Modbus RTU. If you require additional, more complex parameters, please contact Schrack Technik GmbH.

Reg. No.	Name	Function	Format	Multi pl.
500	Bus address	Bus address override (default:1)	uint16_t[-]	1
509	Baud rate	Baud rate override (default: 57600)	uint16_t[-]	1
100	Charging authorisation	0 – Charging not allowed 1 – Charging allowed (overrides E1)	uint16_t[-]	1
127	Charging current setting max.	Max. charging current, 6 – 63 A, pre-set by DIP switch	uint16_t[mA]	1000
507	Charging current setting min.	Min. charging current for 0-10 V - interface	uint16_t[mA]	1000
101	Charging current setting	Active charging current setting (CP)	uint16_t[mA]	1000
303	Temperature	Current temperature	uint16_t[°C]	1
141	PP- charging cable identification	GND, 0, 16, 20, 32, 63	uint16_t[-]	1
139	CP status	A, B, C, D, E, F, U	char [-]	1
151-152	Charging time	Time since charging started	uint32_t[ms]	1
301	Supply voltage	Supply voltage of the module	uint16_t[mV]	1000
302	Mains voltage	Mains voltage, measured at C1	uint16_t[V]	100
148	Voltage E1	Voltage at E1, Volt DC	uint16_t[mV]	1000
149	Voltage E3	Voltage at E3, Volt DC	uint16_t[mV]	1000
150	Error word	1 Bit per error: (see extended Modbus register table)	uint16_t[-]	1
832-847	Version	Firmware version	char32 [-]	1

Table 15 Modbus RTU register charge controller Home & Semipublic

6.2 Configuration of charge controller for CION Pro models

The Pro model is distinguished visually from the offline models by the membrane (LED circle with LED points and meter display window) and is designed differently on the inside. These models have a built-in OCPP charge controller, the master stations also include an LTE modem.

The configuration is done via Micro-USB on a web user interface. Optionally, it can also be accessed via the network, but this would have to be configured first.

Web user interface standard login	
	IP address via micro USB: 192.168.123.123 User name: operator Password: Schrack1230!

6.2.1 Configuration Manual

A detailed Configuration Manual is available separately at	
	www.schrack.com/services/cion-docu

6.2.2 Load management

The charging stations can be connected in any constellation consisting of Pro Online and Pro Ethernet charging stations. The only difference between a Pro Online charging station and a Pro Ethernet charging station is that the Pro Online charging station has a built-in LTE modem.

One of the CION Pro units in the network must be defined as a "DLM master with internal DLM slave", which takes over the load management tasks (communication to DLM slave; communication to master meter TCP/IP). All remaining CION Pros must be defined as "DLM slave".

Up to 250 charging points can operate in a DLM network. However, it is recommended to form smaller DLM networks of approx. 25-50 charging points to ensure a smaller failure rate in the event of a fault. Likewise, an optionally available stand-alone load management charging controller can be used, which can be positioned at the root on the house connection. It has an external RS485 Modbus RTU interface so it can be used with common Modbus master meters.

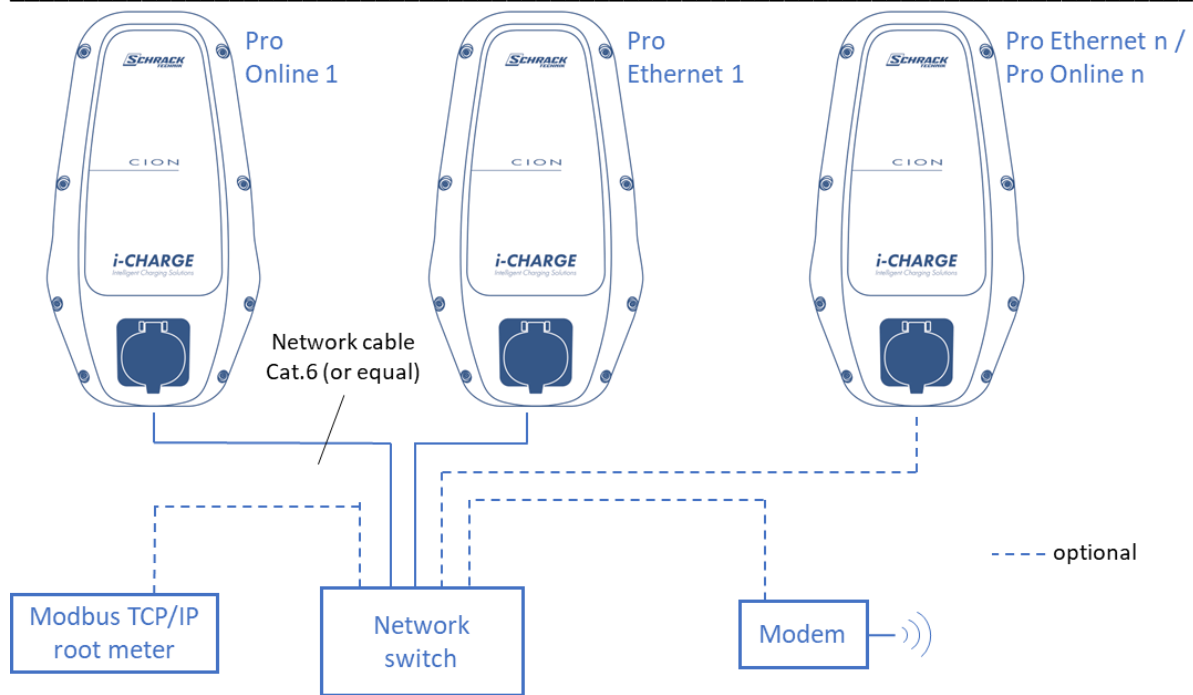

Figure 37 CION Pro wiring schematic

Optional: external modem



Ensure that there is sufficient signal strength!

If necessary, an external modem must be added to guarantee sufficient signal reception.

It must be integrated into the charging station network via Ethernet.

7 Maintenance

The following chapters explain the necessary maintenance activities: inspection, cleaning, servicing, replacement part management, and repair.

INSTRUCTION	
	<p>General information</p> <ul style="list-style-type: none">• The following information must be observed; in addition, the instructions in the respective original manufacturer's documentation must be considered.• The operator assumes responsibility for ensuring that this information is taken into account.• All necessary measures for inspection, repair and servicing must be carried out in accordance with the national regulations of the country of installation.• All maintenance, tests and recurrent tests defined by standards, laws, guidelines and other regulations must be planned and carried out or commissioned by the operator.

7.1 Inspection

The inspection covers the measures to determine and assess the present condition of a product. It serves to detect errors, faults or hazards at an early stage and must be carried out by the user. Such inspection is necessary to ensure safe and fault-free operation.

The following must be taken into account during inspections:

- Visual inspection for damage, corrosion, leakage or deformations of the product
- Visual inspection for contamination and dust deposits
- Check that all warning, mandatory and prohibitory signs on the product are in proper condition
- In addition, a functional test with a BEV or simulator is recommended if regular loading is not carried out.

7.2 Cleaning

The following must be taken into account when cleaning the product:

- The product must be disconnected during cleaning.
- Cleaning can be effected by laypersons who have read and understood the Operating and Maintenance Manual and all the safety instructions.

INSTRUCTION	
	<p>General instructions for cleaning</p> <p>The charging station may only be cleaned using a soft, non-abrasive cleaning cloth.</p>

Carry out cleaning:

- Remove dust and dirt from the complete charging station and all accessories and models using a moist cloth.

7.3 Servicing

Recommended service intervals: annually

INSTRUCTION	
	<p>The following must be taken into account during servicing:</p> <ul style="list-style-type: none">• The product must be disconnected during servicing.• The servicing work must exclusively be carried out by Schrack Technik GmbH or certified i-CHARGE Partners.• Suitable precautions must be taken during all servicing work to ensure that the product cannot be switched on accidentally or without authorisation by the maintenance staff themselves or by third parties.

All requirements necessary for operation must also be met for servicing. (e.g.: access to power supply, access to Operating Manual, availability of charge card or other authorisation media...)

7.4 Spare and wear parts

For information about spare and wear parts, please refer to the Spare and Wear Parts List in the Appendix, see chapter 9.2. Spare and wear parts must be replaced after different hours of operation, depending on wear and tear.

WARNING



Defect during operation

When using non-original spare parts and in case of any modifications, different hazards will exist.

- Only use original spare parts according to the Spare and Wear Parts List.

7.5 Repair

Repairs include activities that go beyond maintenance work and activities to ensure fault-free operation. The repair, after inspection and servicing, completes the maintenance cycle and ensures a long service life of your charging station.

WARNING



Different hazard events

During repair work on the product additional danger points may become accessible.

- The repair work must exclusively be carried out by Schrack Technik GmbH or certified i-CHARGE Partners. These personnel must also have read and understood this documentation.

7.6 Periodic inspection

The periodic inspection according to E 8101 must be carried out once a year by an electrical engineering specialist. This ensures operating safety and reliability. In the process, the functioning of the charging station as well as all safety devices pertaining to the system are checked against applicable laws and standards.

This includes all shutdown conditions and also the back-up fuse according to the data sheet or initial operation report. We recommend an additional annual servicing carried out by Schrack Technik GmbH or certified i-CHARGE Partners.

7.7 Shutdown

The following steps must be carried out to shut down the product temporarily, under consideration of the safety instructions in chapter 3.4:

- End charging
- Disconnect type 2 charging cable from the charging station and then from the BEV (in case of cable models, disconnect directly from the BEV)
- Disconnect from power supply – de-energise product
- Secure the product against unauthorised start-up

7.8 Dismantling

The following steps must be carried out before dismantling the product for final decommissioning, after the steps for temporary shutdown have been completed.

WARNING	
	<p>Inexpert working during the dismantling poses additional hazards.</p> <p>If the product is not dismantled properly, it may be hazardous to people or may be damaged.</p> <ul style="list-style-type: none">• Only electrical engineering specialists are allowed to perform the dismantling work.

The following should be considered when dismantling the product:

- After the shutdown (see chapter 7.7) the charging station must be disconnected from the power supply.
- Transportation may only be carried out in compliance with the transport regulations.
- If the product is put in storage after dismantling, the requirements regarding the storage location must be complied with.
- If the product is disposed of, this must be done in compliance with the disposal principle (see chapter 7.9).

7.9 Disposal

Principle

INFORMATION	
	<p>Disposal - principle</p> <ul style="list-style-type: none">• The disposal of the parts of the product in the course of the decommissioning should be conducted environmentally friendly and according to type (metal to the respective metal scrap, plastic to the plastic waste, electronics to the electronic scrap according to the legal requirements, etc.)

Before disposing of materials and parts of the product, check their recyclability. Recycle as much as possible. Careless or incorrect disposal can result in unforeseeable damage. Dispose of materials and parts of the product in a way that is known to be safe for humans, nature and the environment. Observe the manufacturer's instructions and the relevant laws and regulations.

8 Maximum back-up fuse

Depending on the model and version, the charging station must be equipped with a suitable back-up fuse. For this purpose, it is possible to use a separate MCB plus RCCB or an RCBO, which combines both protective functions in one device. The shown rated currents of the circuit breaker are maximum permissible values. As a rule, the rated current of the charging station should be used for protection, unless it is necessary due to thermal derating.

Three-phase charging stations can and may also be single-phase connected and operated if the charging current does not exceed 16 A (acc. to TAEV specification). To do so, set the configuration as described (see chapter 6).

Other suitable back-up fuses can also be used, provided that the national and country-specific regulations are complied with.

RCCB + MCB

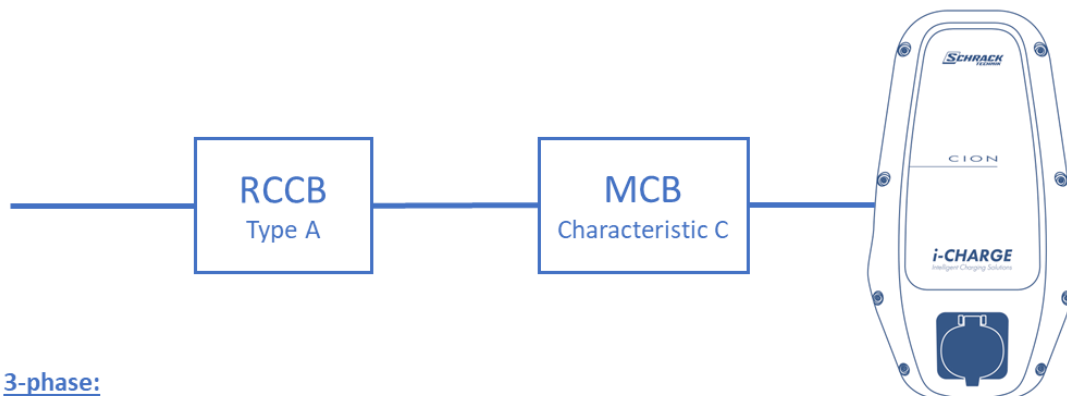

3-phase:

Charging Current	Residual Current Protection	Circuit Breaker	
13 A	40 A / Type A / G / 30 mA Art.no.: BC034403--	16 A / characteristic C Art.no.: BM017816--	i-CHARGE CION 11 and 22 kW Art.no.: EMCIONxxx
16 A	40 A / Type A / G / 30 mA Art.no.: BC034403--	20 A / characteristic C Art.no.: BM017820--	i-CHARGE CION 11 and 22 kW Art.no.: EMCIONxxx
20 A	40 A / Type A / G / 30 mA Art.no.: BC034403--	25 A / characteristic C Art.no.: BM017825--	i-CHARGE CION 22 kW Art.no.: EMCIONx2xx
32 A	40 A / Type A / G / 30 mA Art.no.: BC034403--	40 A / characteristic C Art.no.: BM017832--	i-CHARGE CION 22 kW Art.no.: EMCIONx2xx

1-phase:

Charging Current	Residual Current Protection	Circuit Breaker	
13 A	40 A / Type A / G / 30 mA Art.no.: BC034203--	16 A / characteristic C Art.no.: BM017616--	i-CHARGE CION 11 and 22 kW Art.no.: EMCIONxxxx
16 A	40 A / Type A / G / 30 mA Art.no.: BC034203--	20 A / characteristic C Art.no.: BM017620--	i-CHARGE CION 11 and 22 kW Art.no.: EMCIONxxxx

Figure 38 Back-up fuse schematic

RCBO

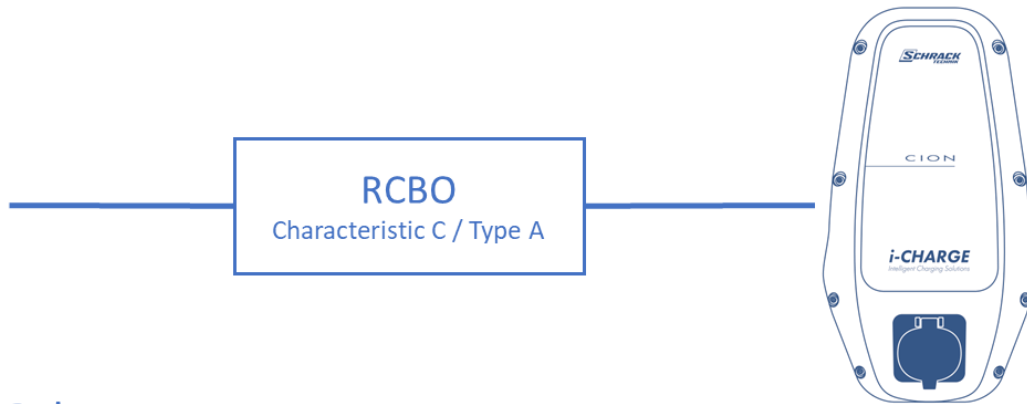

3-phase:

Charging Current	RCBO	
13 A	16 A / C / Type A / 30 mA Art.no.: AK667816--	i-CHARGE CION 11 and 22 kW Art.no.: EMCIONxxxx
16 A	20 A / C / Type A / 30 mA Art.no.: AK667820--	i-CHARGE CION 11 and 22 kW Art.no.: EMCIONxxxx
20 A	25 A / C / Type A / 30 mA Art.no.: AK667825--	i-CHARGE CION 22 kW Art.no.: EMCIONx2xx
32 A	40 A / C / Type A / 30 mA Art.no.: AK667840--	i-CHARGE CION 22 kW Art.no.: EMCIONx2xx

1-phase:

Charging Current	RCBO	
13 A	16 A / C / Type A / 30 mA Art.no.: BO617616--	i-CHARGE CION 11 and 22 kW Art.no.: EMCIONxxxx
16 A	20 A / C / Type A / 30 mA Art.no.: BO617620--	i-CHARGE CION 11 and 22 kW Art.no.: EMCIONxxxx

Figure 39 Back-up fuse schematic

9 Appendix

9.1 Dimensions - drill template

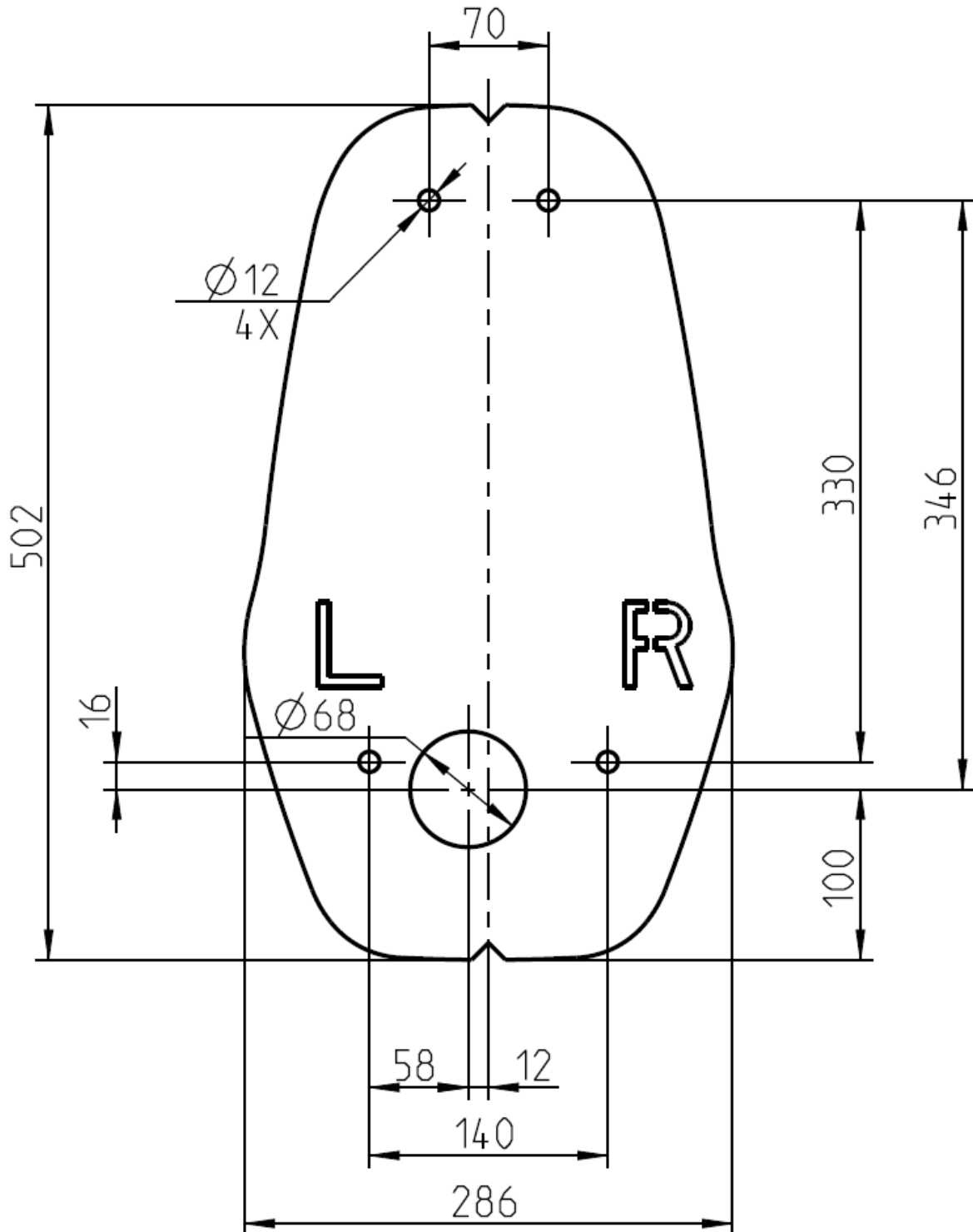

Figure 40 Drill template

9.2 Spare and wear parts

Name	Article number
Socket type 2 for CION Home and Semipublic	EMKBT2P32H
Actuator cable for EMKBT2P32H	EMKBT2BAK- (on request)
Socket lid for EMKBT2P32H	EMKBT2C00-
Socket type 2 incl. socket lid for CION Pro	
Type 2 plug holder	EMKHA02B--
Contactors; 22 kW	BZ326442--
Contactors; 11 kW	BZ326461--
PSU 12 V; 15 W	EMNGPHX15- (on request)
MID meter	MGRZK440--
RFID reader for CION Semipublic	EMCNFCPR--
RFID reader for CION Pro	EMCBENR17-
RCMU for CION Home and Semipublic	EMCEBERCMU
RCMU for CION Pro	EMCBENRCMU
Glass tube fuse, 4 A	On request
Spare cable type 2; 3-phase; 16 A; 5 m	EMK120F0F4
Spare cable type 2; 3-phase; 32 A; 5 m	EMK320F0F4
Spare cable type 2; 3-phase; 16 A; 7.5 m	EMK120F0F5
Spare cable type 2; 3-phase; 32 A; 7.5 m	EMK320F0F5

Table 16 Spare and wear parts

9.3 Unit table

Abbreviation	Meaning
kW	Kilowatt
Hz	Hertz
V	Volt
°C	Degree Celsius
Nm	Newton-metre
%	Percent
mm	Millimetre
m	Metre
s	Second
min	Minute
h	Hour
kg	Kilogramme

Table 17 Unit table

9.4 Packaging icons









ICON	Description		
	The charging station was made in Austria		The charging station is easy to use
	The charging station is weatherproof		With this charging station operating safety is guaranteed
	The charging station is made impact proof (IK10)		The charging station is UV stable
	The charging station was subject to a conformity evaluation process and complies with the legal requirements		The charging station can be mounted indoors and outdoors

Table 18 Packaging icons

9.5 Notes

Further information can also be found on the Internet at www.schrack.com/services/cion-docu.



SCHRACK TECHNIK GmbH.
Seybelgasse 13, 1230 Vienna, Austria
TELEPHONE +43 1 866 85 ext. 0
EMAIL info@schrack.com

Company Register No. 318049 w, TAX ID/VAT NO.: ATU64541204,
Packaging Compliance ARA LICENCE NO: 7600, DPR No.: 0665649-v